

# MULTIPHYSICS SIMULATION

Sponsored by  
 COMSOL

---

 IEEE  
**SPECTRUM**

SEPTEMBER 2016



KONICA MINOLTA  
**MODELS SURFACE  
PLASMONS TO  
BRIGHTEN OLEDs**

**PAGE 24**



---

GRAFTECH  
**COOLS OFF  
ELECTRONICS  
WITH GRAPHITE  
SOLUTIONS**  
PAGE 3

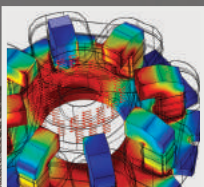

---

ST. JUDE MEDICAL  
**DESIGNS NEXT  
GENERATION WIRELESS  
IMPLANTABLE DEVICES**  
PAGE 7

# A NUMERICAL ANALYSIS BEHIND EVERY DESIGN

By **JAMES A. VICK**, PUBLISHER, IEEE SPECTRUM

TODAY'S FAST-PACED DEVELOPMENT of new technologies and products is quite remarkable. To remain competitive, businesses focus on design innovation. Many organizations rely on mathematical modeling and numerical simulation to get their designs right, or as close to real-world ready as possible, early in the development cycle. The benefits they have found are many, including shorter time to market and higher quality products.

This year's issue of *Multiphysics Simulation*, sponsored by COMSOL, serves as a great overview of how organizations use numerical simulation. In the pages that follow you will find applications such as plasmonic nanoantennas, centrifugal heart pumps, 5G for the Internet of Things (IoT), and acoustic cloaking.

Of particular interest is the expansion of simulation throughout organizations with access to specialized, easy-to-use simulation apps. The article from GrafTech, a leader in graphite solutions for industrial applications, highlights the full picture of this growing trend. The research team developed a detailed model of graphite heat spreaders used in the thermal management of smartphones, then turned their simulation into an app for their sales team to use when creating specifications for designs requested by customers. The heat spreader app and other examples like it allow users to test the validity and performance of different designs without requiring simulation expertise, deploying the knowledge of the simulation specialists to colleagues, collaborators, and even customers.

Read on to learn how numerical analysis is being leveraged as a powerful tool in many industries, in this issue of *Multiphysics Simulation*. ©

Email: [jv.ieeemedia@ieee.org](mailto:jv.ieeemedia@ieee.org)

**ON THE COVER:** Lighting design master Ingo Maurer's collaboration with Konica Minolta resulted in this pioneering OLED product, Whisper Wind. The lamp consists of 25 OLED flexible panels that are attached to a double-sided steel branch structure with magnets, which also serve as a power conductor. See the full article on page 24 for more details about modeling OLEDs.

Photo is courtesy of Ingo Maurer.



## CONTENTS

### 3 INDUSTRIAL APPLICATIONS OF CARBON AND GRAPHITE FOR THERMAL MANAGEMENT

—GrafTech International, USA

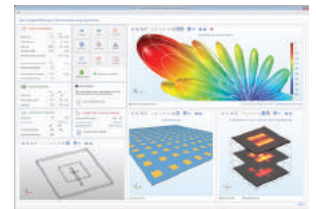

### 7 ENHANCING PERFORMANCE AND SAFETY OF MEDICAL IMPLANTABLE DEVICES WITH MULTIPHYSICS SIMULATION

—St. Jude Medical, USA

### 10 LIGHT, STRONG, AND DEFECT-FREE LASER WELDING: PERFECTING THE PROCESS FOR THE AUTOMOTIVE INDUSTRY

—ArcelorMittal, France

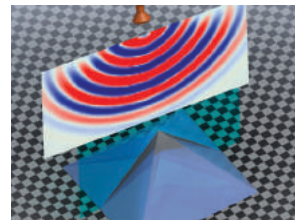

### 13 MANIPULATE AND CONTROL SOUND: HOW MATHEMATICAL MODELING SUPPORTS CUTTING-EDGE ACOUSTIC METAMATERIALS RESEARCH

—Duke University, USA

### 16 VIRTUALLY TUNING AN AUTOMOTIVE AUDIO SYSTEM

—HARMAN, France

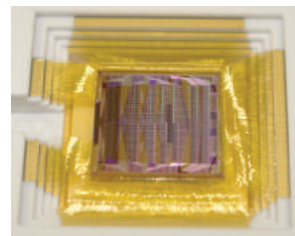

### 18 DESIGNING ENERGY-EFFICIENT PHOTONIC SWITCHES TO SUPPORT GROWING NETWORK TRAFFIC

—Huawei, Canada

### 22 OUR 5G FUTURE: IN THE FAST LANE WITH NUMERICAL SIMULATION

—COMSOL, USA

### 24 LET THERE BE LIGHT: A BRIGHTER FUTURE FOR OLEDs

—Konica Minolta, USA

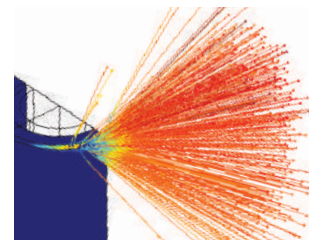

### 27 FROM NANOANTENNAS TO DEEP SPACE SATELLITES, ELECTRON EMISSION ENABLES EFFICIENT POWER GENERATION

—IIT, Italy

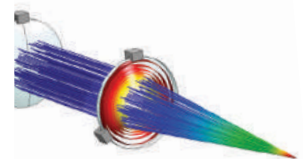

### 30 RAY OPTICS SIMULATION LIGHTS THE WAY FORWARD

—COMSOL, USA

### 32 COMPUTATIONAL NANOPHOTONICS: FROM OPTICAL BLACK HOLES TO PLASMON TWEZERS

—Purdue University, USA

# INDUSTRIAL APPLICATIONS OF CARBON AND GRAPHITE FOR THERMAL MANAGEMENT

At GrafTech International, carbon and graphite products are designed and manufactured for use in everything from industrial induction furnaces to consumer electronics. Numerical analysis is the key to design and process optimization for any application, making it possible to maximize performance while keeping power consumption and material expenditures in check.

By JENNIFER SEGUI

**IDENTIFYING AND DESIGNING** the best materials for a particular thermal management application can be a challenging task, where industrial designers are presented with countless options from suppliers, and often not enough information to make an informed decision.

Researchers and engineers at GrafTech International place significant value on understanding their products, allowing them to provide their customers with the information they need to select the right carbon and graphite solutions.

“To better understand our products and how they perform in the context of a particular thermal management application, we are using numerical simulation in combination with physical testing,” explains Richard Beyerle, a senior scientist in the Innovation and Technology group at GrafTech. “The latest computational tools that we have under development may also be used by our sales engineers, field specialists, and customers to compare how our products perform in virtual prototypes before proceeding to physical implementation and testing.”

An example of one such tool, a computational application, is shown in Figure 1. The application provides a user-friendly interface to an underlying mathematical model, making it straightforward for anyone who would benefit to run simulations.

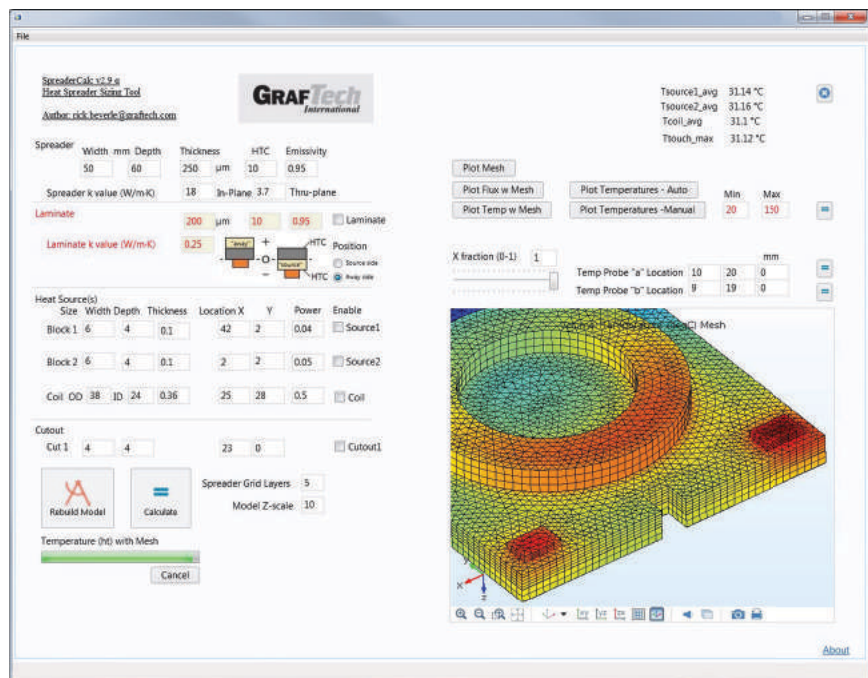

Figure 1. A simulation application combines a user-friendly interface with an underlying multiphysics model, extending analysis capabilities to a broad pool of users. This app allows its user to compare heat transfer among graphite foils, which are used to dissipate heat in consumer electronics. Image courtesy of GrafTech International.

The use of numerical simulation, and more specifically multiphysics modeling, is prevalent throughout the Innovation and Technology group. “Actually, all of our products and applications have seen the use of multiphysics simulation,” says Ryan Paul, Innovation & Technology Manager at GrafTech.

In their work, Beyerle, Paul, and senior scientist Nathanael May use multiphysics modeling and simulation applications to better understand the electrical, structural, and thermal performance of carbon and graphite, as well as for design and process optimization for several industrial applications.

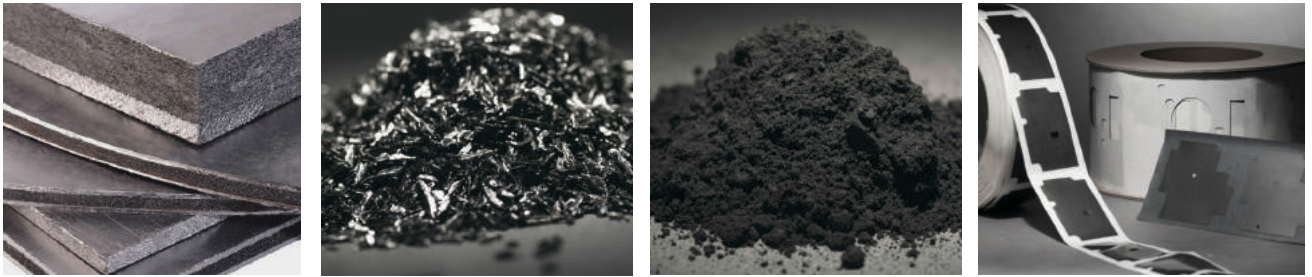

Figure 2. The advanced material solutions designed and manufactured by GrafTech include rigid composite sheets, expanded flakes, powders, and flexible graphite foils, among many other custom options. Photo courtesy of GrafTech International.

“The [simulation apps] that we have under development may also be used by our sales engineers, field specialists, and customers to compare how our products perform in virtual prototypes.

— RICHARD BEYERLE,  
SENIOR SCIENTIST,  
GRAFTECH INTERNATIONAL

### » UNDERSTANDING CARBON AND GRAPHITE

THE ADVANCED MATERIAL solutions manufactured by GrafTech from carbon and graphite are available in many physical forms including rigid sheets, felts, powders, flexible foils, and custom-machined structural elements, a selection of which are shown in Figure 2. Both amorphous carbon and graphite are depicted in Figure 3 for comparison, and are made up of the chemical element, carbon. Relative to amorphous carbon, graphite has a highly ordered structure consisting of many planar layers. Within a single layer of graphite, a honeycomb lattice is observed, where covalent bonds between carbon atoms produce a hexagonal arrangement.

The structure of graphite results in excellent in-plane electrical and thermal conductivity, particularly in comparison to amorphous carbon. Graphite is also extremely strong, with a single layer of graphite, referred to as graphene, being the strongest

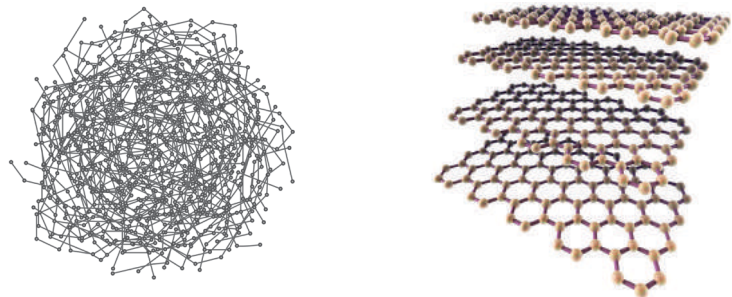

Figure 3. Compared with amorphous carbon (left), graphite has a highly ordered structure consisting of individual layers of graphene (right).

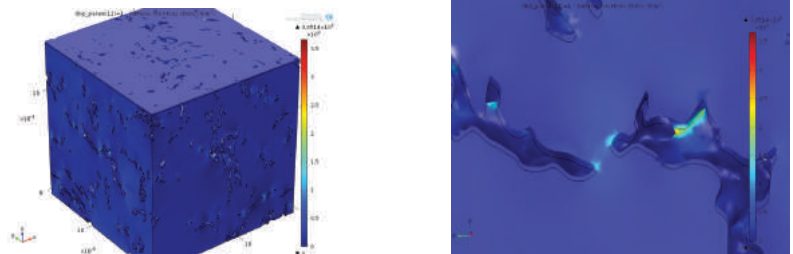

Figure 4. A reconstructed volume of graphite showing material porosity was generated using computed tomography (CT) and imported into COMSOL® software for simulation. The validated model is being used to investigate the effect of porosity on the elastic properties of synthetic graphite. Images courtesy of GrafTech International.

material on record. However, weak bonding via van der Waals forces between the layers in graphite results in lower through-plane electrical and thermal conductivity, which gives graphite its highly anisotropic properties. Individual layers are also able to slide past each other making the bulk material relatively soft. Many forms of graphite, however, can withstand temperatures in excess of 3000 degrees Celsius in

a non-oxidizing atmosphere.

In order to use graphite in applications where thermal management is important, and benefit from its unique thermal properties, it is necessary to better understand how the material performs overall. A combination of physical characterization and simulation in COMSOL Multiphysics® software is being used at GrafTech for this purpose, as shown in Figure 4.



Figure 5. Flexible graphite foil heat spreaders enable dissipation of heat from an electronic component with high in-plane conductivity, while protecting underlying heat-sensitive areas with low through-plane conductivity. Photo courtesy of GrafTech International.

heat spreaders, for example, are among the graphite foils available, and are designed for use in different applications such as smartphones, tablets, and displays. Figure 5 illustrates how graphite heat spreaders work to cool an electronic component or device, which allows them to operate at lower temperatures, extending their lifetimes and improving their performance.

Graphite foil heat spreaders come in a select range of thicknesses, electrical and thermal conductivities, contact impedances, and coating options. “It is a common challenge to balance the desired thermal performance and cost,” says Beyerle. “Numerical simulation is an excellent way to evaluate how a graphite foil will perform for cooling electronic components in a particular device, enabling us to identify the most cost-effective solution for our customers without compromising performance.”

To evaluate anisotropic heat transfer, and the performance of flexible graphite foils for thermal management in various electronics applications, Beyerle is developing mathematical models and simulation applications in COMSOL Multiphysics® software. One custom application enables the user to evaluate graphite heat spreaders in geometries that are relevant to portable electronic devices, such as cell phones, and was introduced in Figure 1.

The application provides the ability to change the location and size of heat sources, slots, and other openings, specify the heat source power, and visualize the finite element mesh and simulation results. Figure 6 shows how changing the slot length, for example, can affect heat

“The design challenge is to model the temperature-dependent properties and performance of graphite under dynamic thermal-mechanical-electrical loads,” explains Paul. “By modeling graphite and its applications, learning happens much faster, and builds on experiment by deepening our understanding of the mechanisms and theory, something experimental data alone cannot deliver.”

### » MODELING GRAPHITE FOIL FOR ELECTRONICS COOLING

**FOR ONE POTENTIAL APPLICATION** — the thermal management of electronic components — GrafTech designs and manufactures thin flexible graphite foil. SPREADERSHIELD™

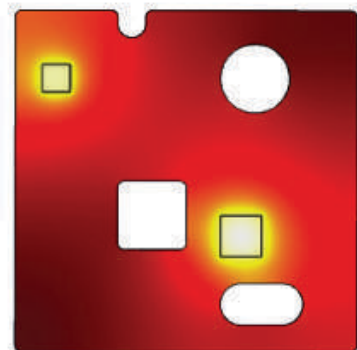
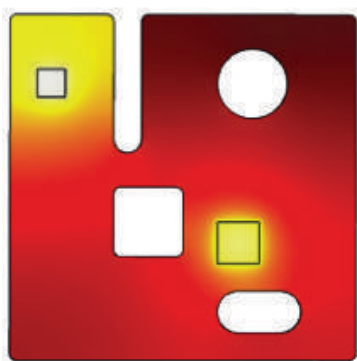

Figure 6. By using GrafTech’s simulation application, heat dissipation throughout a graphite heat spreader can be evaluated, taking into account the size and placement of heat sources as well as the size of cutouts. Images courtesy of GrafTech International.

“By modeling graphite and its applications, learning happens much faster, and builds on experiment by deepening our understanding of the mechanisms and theory, something experimental data alone cannot deliver.”

— RYAN PAUL, INNOVATION AND TECHNOLOGY MANAGER, GRAFTECH INTERNATIONAL

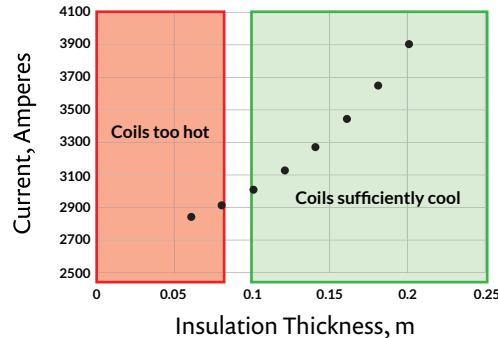
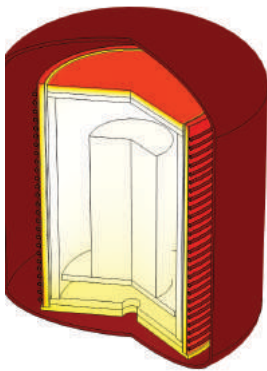

Figure 7. At left, temperature distribution from simulation of a furnace with water-cooled induction coils. Right, results demonstrate the optimal graphite insulation layer thickness required to cool the coils. Images courtesy of GrafTech International.

dissipation from a nearby source.

To ensure the simulation app is a useful tool, an important step is verifying the underlying mathematical model. A particular concern for Beyerle is the accurate simulation of anisotropic heat transfer in both flat and curved layers of graphite heat spreaders. In this case, if the simulation is not accurate, the results could make the unique performance of graphite appear similar to that of an ordinary metal. In COMSOL® software, it is straightforward to create a user-defined coordinate system for modeling anisotropic material properties, including in curved or branched parts.

Running a simulation through the app was designed to be quick, taking less than 12 seconds, making the tool convenient for use during the sales cycle. By using an installation of the COMSOL Server™ product, Beyerle is able to host the simulation app on local hardware at GrafTech, while giving colleagues and customers the ability to run the app remotely from a COMSOL Client for Windows® operating system or from a web browser.

### » OPTIMIZING FURNACE DESIGN AND OPERATION

DESPITE THE NUMEROUS ADVANTAGES of using graphite in practice, the anisotropic and highly temperature-dependent properties of the

“Virtual prototyping through mathematical modeling is very useful for increasing the confidence of potential customers, allowing us to demonstrate that GrafTech’s solutions are thoroughly vetted.”

— NATHANAEL MAY,  
SENIOR SCIENTIST,  
GRAFTECH INTERNATIONAL

many unique grades of materials manufactured by GrafTech can be challenging to model accurately – a challenge clearly shared by Beyerle and Paul, as well as by their colleague Nathanael May, a senior scientist also in the Innovation and Technology Group.

“Having many unique grades of materials means we have to do the lab work to build a database of material properties that we can use in our models,” explains May. “The effort is easily justified, though. Virtual prototyping through mathematical modeling is very useful for increasing the confidence of potential customers, allowing us to demonstrate that GrafTech’s solutions are thoroughly vetted.”

One of May’s major projects is dedicated to creating a sophisticated multiphysics model using COMSOL Multiphysics. “I am mostly creating models for simulating

high-temperature furnaces, in 2D and 3D, such as induction furnaces, vacuum furnaces, and high-quality crystal growth furnaces,” says May.

An example of an induction furnace from May’s work, as well as results from design optimization performed using numerical simulation, is shown in Figure 7. Simulation was used to optimize the thickness of a GRAFSHIELD™ carbon bonded graphite insulation layer in order to prevent temperatures from exceeding 100 degrees Celsius in the water-cooled induction coils. Additionally, keeping the insulation layer as thin as possible reduces the amount of current required to maintain the furnace temperature.

### » THE WIDE WORLD OF CARBON AND GRAPHITE

WHEN IT COMES TO GAINING a better understanding of the performance of GrafTech’s unique carbon and graphite solutions, modeling and simulation are essential. Equally adept at both experimental characterization and computational modeling, Beyerle, Paul, and May are combining the two, making application-specific information about GrafTech’s solutions available.

By developing and deploying custom applications — an exclusive capability in COMSOL Multiphysics® software — GrafTech can provide easy-to-use, simulation-based design capabilities for thermal management applications. In this way, simulation applications not only open up the wide world of carbon and graphite, but numerical analysis as well, to any colleagues or potential customers who would benefit. ☺



Richard Beyerle is a senior scientist in the Innovation and Technology Group at GrafTech International.

# ENHANCING PERFORMANCE AND SAFETY OF MEDICAL IMPLANTABLE DEVICES WITH MULTIPHYSICS SIMULATION

*At St. Jude Medical, ventricle assist devices are developed to improve the lives of patients with heart failure. Numerical simulation is used throughout the design process to characterize diverse concurrent aspects of the design, from thermal effects and fluid dynamics to power transfer.*

By SARAH FIELDS

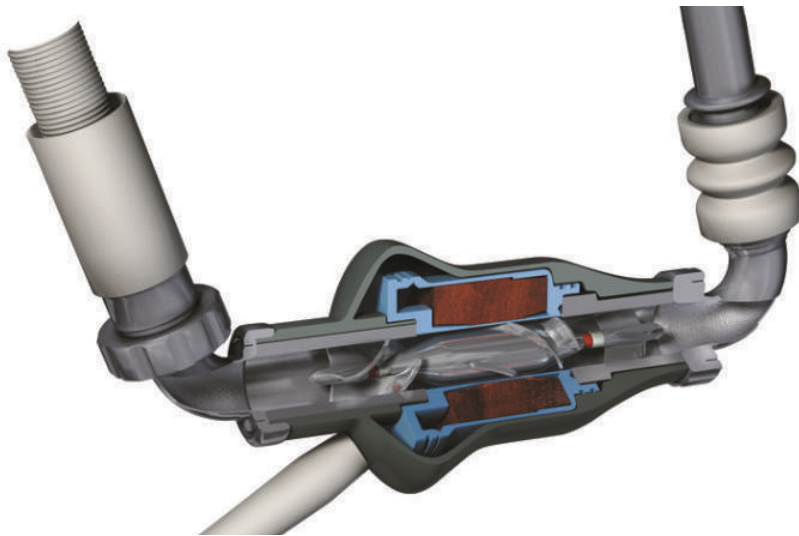

Figure 1. An LVAD pump is responsible for circulating oxygen-rich blood throughout the body. Image courtesy of St. Jude Medical.

**THE DEVELOPMENT OF A DEVICE** meant to assist or completely replace functioning of the heart is undeniably complex. This design process involves immense challenges, from supplying power to the device to ensuring it does not interfere with normal biological functioning. Researchers at St. Jude Medical use multiphysics simulation to engineer LVADs, Left Ventricular Assist Devices, in an ongoing effort to improve the outlook and quality of life of patients with heart failure.

The condition typically begins with

the left side of the heart, as the left ventricle is responsible for pumping oxygen-rich blood throughout the body, a greater distance than the right ventricle, which pumps blood through the lungs. Often, in patients with a poorly functioning left ventricle, an LVAD (see Figure 1) can provide mechanical circulatory support.

The ventricle assist device is one of the most complex machines ever implanted in a human being. An LVAD must circulate the entire human blood stream and support

life, as well as be compatible with the internal environment of the human body. Thoratec, now part of St. Jude Medical, brought LVADs to a wide market in 2010, after years of clinical trials.

## » DESIGNING A POWERFUL, EFFICIENT, AND HEMOCOMPATIBLE PUMP

**THE DESIGN OF AN LVAD** must take many factors into consideration. The device must be small enough to connect to the heart and be made of compatible materials and geometry that permit the device to reside in the body without being rejected. Fluid dynamics, power supply, and thermal management must also be considered. As multiple interacting physical effects must be accounted for at each area of development, multiphysics simulation is vital to the design process.

Freddy Hansen, Sr. R&D Engineer at St. Jude Medical uses his expertise in physics and mathematical modeling to characterize complex implantable medical devices like LVADs before experimental studies.

Hansen has been using COMSOL Multiphysics® software in 2011, and has since created upwards of 230 models that address a wide range of design challenges pertaining to the unique physics of artificial pumping devices.

“I use COMSOL Multiphysics every day, from proof of concept models to quite sophisticated simulations featuring detailed CAD geometries and coupled physics. I work with some complex models for months before I’ve taken all of the information I want from them.”

With each generation of LVADs introduced to market, improvements are made that contribute to enhanced safety and quality of life for the patient. Research and development efforts at St. Jude Medical are centered on improving biocompatibility, hemocompatibility, and immunocompatibility, such that the device does not illicit an adverse immune response, nor interfere with other bodily systems.



Figure 2. External equipment of an LVAD. Image courtesy of St. Jude Medical.

Geometry and size of the device play an important role in its overall effectiveness. To implant the LVAD, the surgeon connects one end of the LVAD to the left ventricle and the other end to the ascending aorta (see Figure 2). If the device is smaller, it is less cumbersome, and less likely to interfere with neighboring organs or tissue. Simulation allows for the evaluation of changes in size or geometry of the LVAD design before implementation of a physical prototype.

### » OPTIMIZING LVAD DESIGN FOR BIOCOMPATIBILITY

MANY SIMULATIONS WERE USED in the development of the centrifugal pump of the LVAD. One challenge associated with engineering these devices is the prevention of blood clotting in any space in or around the pump. To address this, a magnetically levitated rotor was developed, which eliminated the need for ball bearings and other components with geometries that might promote clotting. Hansen used

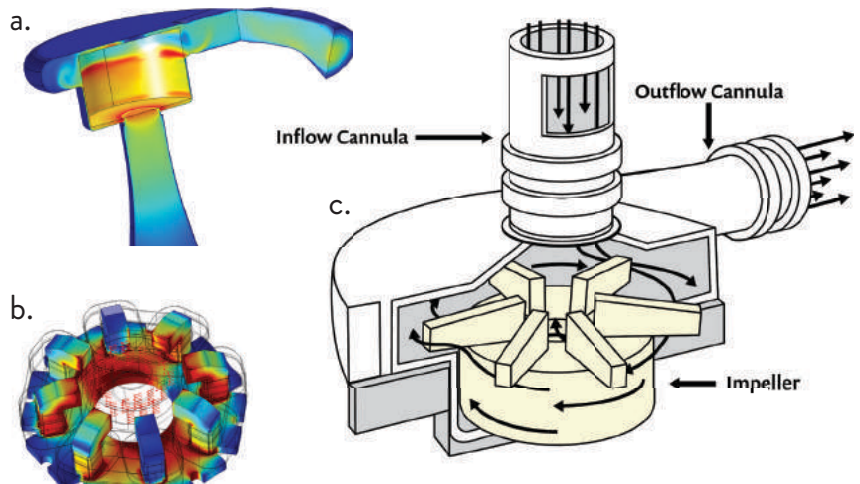

Figure 3. (a) 3D CFD simulation depicting fluid velocity within the pump chamber. (b) Visualization of the magnetically levitated rotor, which eliminates the need for ball bearings and other components with geometries that might promote clotting. Here, the magnitude and direction of the magnetic field in the rotor, as well as the magnitude of the magnetic field in the stator are shown. (c) Diagram of the centrifugal pump of an LVAD.

the Rotating Machinery modeling technology available in the software to model both the magnetically levitated rotor and turbulent fluid flow.

A permanent magnet in the pump rotor is driven by coils in the stator, which exert a torque on the rotor and provide active control of the position of the rotor axis. The vertical position — or levitation — of the rotor is accomplished by magnetic field line tension and does not need active control. The rotor receives blood axially and redirects it radially, into the volute, or fluid collector (see Figure 3). Some of the blood flows back around the outer edge of the rotor and into the rotor inlet, resulting in a constant washing of the blood, which serves to eliminate places where the blood can stagnate and clot.

Another significant advance was the development of a pump system with pulsatile flow, rather than continuous flow, which more closely mimics a functioning heart. The pulsatile flow aids in the washing of the blood, preventing blood clots, and is also believed to have a positive physiological effect on blood vessels throughout the body.

### » WIRELESSLY POWERING A FULLY-IMPLANTABLE LVAD

CURRENT LVADS REQUIRE POWER transfer from external batteries in a controller outside the body to the pump by way of a cable, made with materials engineered to be biocompatible. But what if the cable could be eliminated?

Hansen explored transferring power by way of magnetic resonance coupling. Magnetic resonance coupling occurs when two objects, having almost the same resonance frequency, transfer energy to each other through their oscillating magnetic fields. In this way, power can be transferred from a power source to another device, even through a biological medium such as tissue.

A Fully Implantable LVAD System (FILVAS) would decrease infection risk and improve patient quality of life, as the patient would not need to be concerned with cable management. With this concept

“ I use COMSOL Multiphysics every day, from proof of concept models to quite sophisticated simulations featuring detailed CAD geometries and coupled physics. I work with some complex models for months before I’ve taken all of the information I want from them.

— FREDDY HANSEN, SENIOR R&D ENGINEER, ST. JUDE MEDICAL



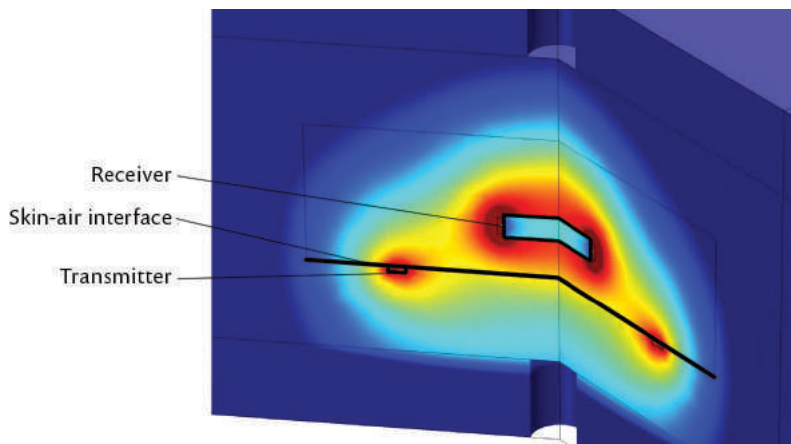

Figure 4. Model of heating induced in the body through magnetic power transfer. Results show power density distribution in the tissue and the surrounding air.

the patient could shower or swim without concern for the cable.

To assess the feasibility of wireless power transfer to an LVAD and determine how much power could be transferred between reasonably sized coils, Hansen coupled a 3D magnetic field model with an electrical circuit model to determine operating efficiency and power loss, as well as optimal circuit design and component values.

He evaluated different materials for important components, such as the wires of the transformer coils. He also studied the misalignment of a coil due to patient walking, running, and other activities, together with the effect of the presence of nearby magnetic or metallic objects.

Engineers also had to ensure that body temperature and biological systems would not be affected by the implant. The wireless transfer of energy induces small currents in the body tissue near the coils. Hansen modeled the heat generated in the tissue as a result of the induced currents, combined this with models of heat generated inside the implant (in magnetic wires, electronics, and batteries), and then used the thermal conductivity coefficient determined from a famous Cleveland Clinic experiment, to determine the temperature increase in body tissue near the implant (see Figure 4).

## » PROTECTING LIFE-SUSTAINING BATTERIES

PATIENTS MUST LIVE WITH their LVADs every single day, which inevitably means that the external LVAD controller must be able to withstand the wear and tear of life, as well as the occasional dropping of the controller to the floor. To ensure that the controller (which contains crucial life-saving batteries) will continue to function even if the patient tosses it around, Hansen developed a mechanical impact analysis of the controller in order to assess its resilience (Figure 5).

He also analyzed the edges and surfaces of the deformed structural shell and the frame for twisting, to verify the integrity of the controller. The analysis proved the controller would continue to provide life-sustaining power to the LVAD even after a substantial impact.

## » NEW TECHNOLOGY SHOWS IMPROVED OPTIONS FOR PATIENTS IN THE FUTURE

IN DESIGNING DEVICES TO ASSIST and replace the function of the heart, multiphysics analysis has proven to be essential. Hansen combines experimental characterization and mathematical modeling to understand the physics pertaining to ventricle assist devices, and improve the

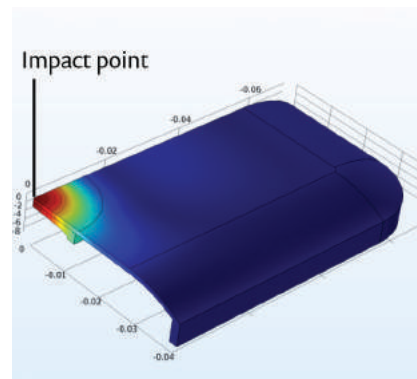

Figure 5. Simulation of a steel ball impacting an LVAD controller to evaluate resiliency of the controller. Visualization shows displacement along the vertical axis.

biocompatibility of the device as well as the overall patient experience.

The latest innovations to mechanical pumping systems — including a smaller device size, a more hemocompatible pump and the introduction of pulsatile flow, and now the possibility of wireless power transfer — hold much promise for better treatment in the future. ©



### FREDDY HANSEN

received his undergraduate degree in engineering physics from Chalmers

University of

Technology in Gothenburg, Sweden. He received his master's, PhD, and postdoc in applied physics at Caltech, specializing in plasma physics related to spacecraft plasma propulsion. Following this, he worked nine years at Lawrence Livermore National Laboratory doing research in fluid dynamics, astrophysics, and nuclear fusion. He has also written over 40 research papers; has half a dozen patents, pending or approved; and co-created a popular college physics textbook. Freddy is currently working at St. Jude Medical using his expertise in electromagnetics and fluid dynamics to design artificial hearts.

# LIGHT, STRONG, AND DEFECT-FREE LASER WELDING: PERFECTING THE PROCESS FOR THE AUTOMOTIVE INDUSTRY

*Between reducing emissions, constantly improving safety, and keeping costs low, the automotive industry faces challenges arising from recent shifts toward eco-friendly vehicles. Engineers at ArcelorMittal are optimizing the use of material for automotive design that meets safety standards and decreases environmental footprint.*

By **LEXI CARVER**

**SAFETY. ENVIRONMENTAL IMPACT. COST-EFFECTIVE DESIGN.** The number of factors an automotive manufacturer must consider when developing a car is staggering. With safety standards that continue to evolve over time, and the ever-present need to reduce emissions and price, one area that has major impacts on all of these concerns is the design and weight of the vehicle.

Automotive manufacturers rely on laser welded blanks (LWBs), which comprise metal sheets of different thicknesses and grades, to minimize and control the amount of material employed in different regions of a car, such as the frame and body (see Figure 1). Among other regulations, these blanks must keep up with crash safety requirements.

Enter ArcelorMittal, a company that produces strong, high-quality steel. Through numerical simulation, they are optimizing their LWB welding process to create blanks that ensure proper performance and minimize part weight by finding the best combination of different grades and thicknesses in their welded steel sheets.

## » MEETING CRASH AND EMISSION REQUIREMENTS

“WE OPTIMIZE STEEL PLACEMENT so that certain regions of a car are thinner and lighter but still strong enough, using advanced high-strength and

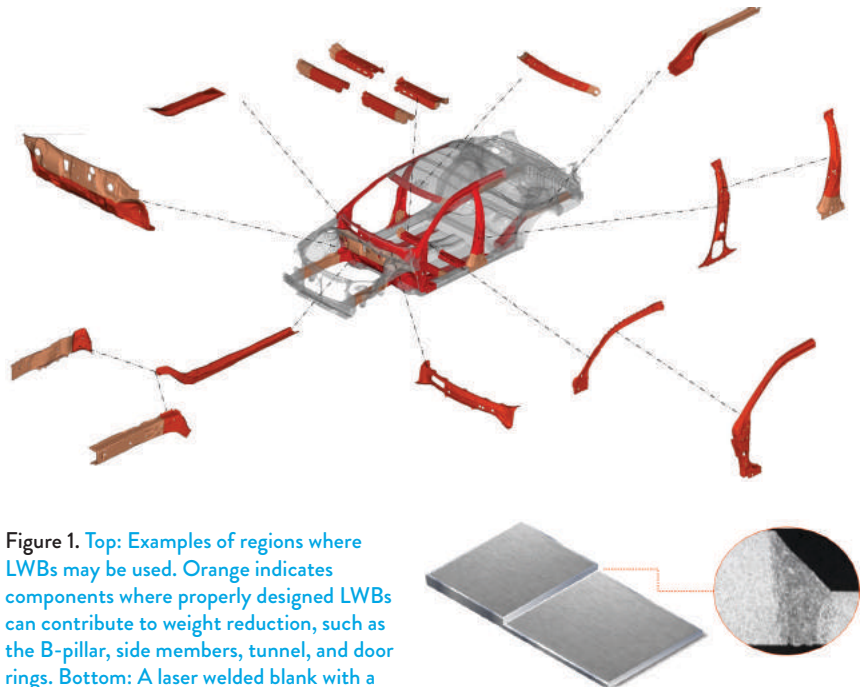

Figure 1. Top: Examples of regions where LWBs may be used. Orange indicates components where properly designed LWBs can contribute to weight reduction, such as the B-pillar, side members, tunnel, and door rings. Bottom: A laser welded blank with a zoomed section showing the butt weld.

press-hardened steels. Ultimately, we want excellent weld quality that meets safety requirements for crash tests,” remarks Dr. Sadok Gaied, who manages a team at ArcelorMittal working on modeling and simulation of welding. For a weld to be considered safe, it cannot crack, break, or otherwise fail during a test.

ArcelorMittal uses laser welding to transform solid steel into molten metal by providing a concentrated heat source, allowing for narrow, deep welds (see Figure 2). “The high-power

laser applies so much energy that some of the metal vaporizes. When the steel melts, its density suddenly decreases and volume and material movement increase, generating a very high-pressure vapor. This creates a ‘keyhole,’ a narrow hole at the point of laser impact,” Gaied explains. “Then the surrounding steel melts, forming a molten pool. When that cools, it creates a connection between the two sheets of metal.”

“Most mechanical failures originate from defects in joining, because the

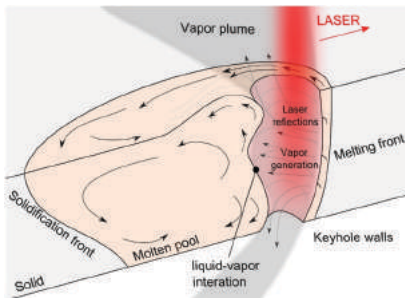

Figure 2. Keyhole creation and the molten steel pool during laser welding. The keyhole migrates as the laser moves along the seam between two sheets, with molten steel filling in the space around and behind it as it travels.

joint is where different materials are connected. If the joint is done improperly, you can end up with stresses that are too high.” Welding with inappropriate parameters can also create instabilities that result in porosity in the weld, partial penetration, or undercutting, which results in a weaker connection. Examples of different weld defects are shown in Figure 3.

“To predict defects for different welding situations, we use numerical simulation that allows us to investigate the effects of changes in parameters like the laser power level,” Gaied continues. “In this way we can virtually test how operating conditions affect the likelihood of defects, as well as predict the fluid dynamics, thermal behavior, and final shape of the weld.”

**“ We can virtually test how operating conditions affect the likelihood of defects, as well as predict the fluid dynamics, thermal behavior, and final shape of the weld. ”**

— SADOK GAIED, PROJECT MANAGER, ARCELORMITTAL

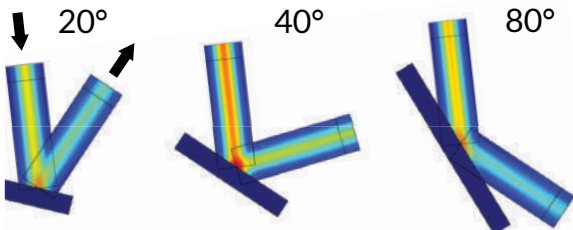

Figure 4. COMSOL® software simulation of the laser reflection. Results show the electric field norm for different angles of reflection, resulting in different amounts of energy absorbed.

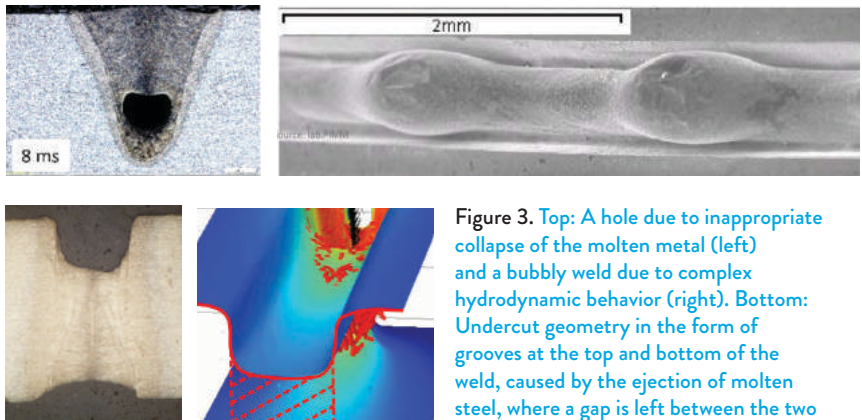

Figure 3. Top: A hole due to inappropriate collapse of the molten metal (left) and a bubbly weld due to complex hydrodynamic behavior (right). Bottom: Undercut geometry in the form of grooves at the top and bottom of the weld, caused by the ejection of molten steel, where a gap is left between the two sheets (left). Simulation results show fluid distribution near the keyhole and the predicted undercut in the weld geometry (right).

### » UNDERSTANDING HOW OPERATING CONDITIONS IMPACT WELD QUALITY

#### WITH THE NUMBER OF FACTORS

influencing the quality of a weld, the devil’s in the details: laser power, material reflection off the laser beam, welding speed, and wavelength affect behavior around the keyhole such as heat transfer, phase change, and fluid flow. In particular, the keyhole angle and shape of the molten pool influence fluid flow behavior resulting from the phase change and thermal loading.

“Fluid, thermal, and electrical behavior are all intertwined here,” Gaied says. “It’s very important to know what’s happening in the weld in order to prevent defects. We needed to study all the physics together in order to track the fluid flow in and around the keyhole and understand its effect on the weld stability.”

Gaied’s team collaborated with Mickael Courtois, Muriel Carin, and Philippe Le Masson from Université Bretagne Sud and used COMSOL Multiphysics® software to analyze the temperature distribution in the molten and solid steel, the angle of the keyhole, and the fluid flow field as they change throughout the welding process. They included several studies

in one COMSOL® software simulation, beginning with an electromagnetic model that determined reflection and material absorption properties based on the angle of the laser’s reflection (see Figure 4).

They also tested changing the power level, wavelength, and welding speed in order to predict the keyhole shape for different operating conditions. This model described the heat transfer and phase change as the metal melted, allowing the team to analyze the resulting vaporization, fluid dynamics of the liquid-vapor interface, and the growth of the molten pool (see Figure 5).

### » MODELING COUPLED BEHAVIOR SHEDS LIGHT ON FINAL WELD RESULTS

**TO PREDICT THE FINAL SHAPE** of the joint, Gaied’s team and the team from Université Bretagne Sud then modeled the penetration depth of the weld as a function of welding speed, laser power, and the size of the keyhole, based on results from their earlier study.

Full penetration into the sheets is required for a high-quality weld; partial penetration can occur when energy density is limited, at low power or high speed. Partial penetration can cause undercuts, resulting in a gap remaining between the two blanks (see Figure 6).

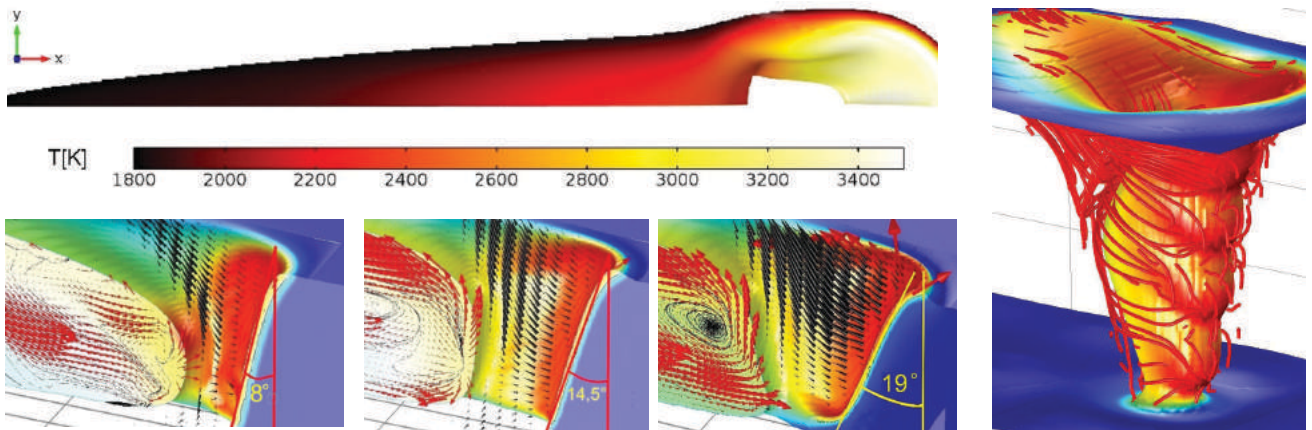

Figure 5. Top left: Temperature field in the molten steel flowing around the keyhole. Bottom left: Results showing capillary inclination (keyhole angle) for different welding speeds, the temperature field in the surrounding metal, and the fluid flow field in the molten pool and the keyhole (arrow plots). Right: Three-dimensional view of the fluid flow directly around the keyhole during its formation. [1]

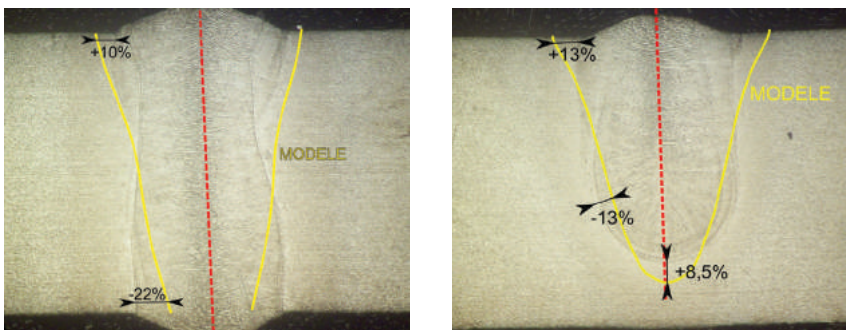

Figure 6. Comparison between COMSOL results (yellow curve) and experiments showing the penetration depth and shape of the weld defect. Penetration depth for welding speeds of 6 m/minute (left) and 8 m/minute (right) with a 4kW laser. The slower case achieves full penetration, indicating sufficient energy density in the deposition. The faster case results in only partial penetration, indicating that there was not enough energy to create a high-quality connection. [2]

» **PERFECTED WELDING TECHNIQUES FOR SAFETY AND EMISSION REDUCTION**

OFFERING THE RIGHT LWBS to their customers — with the appropriate steel grade and sheet thicknesses to accommodate crash test specifications, weight requirements, and cost — requires choosing the right combination of welding parameters. Based on their simulations, Gaied’s team helps determine a range of operating conditions for defect-free joints.

“Being able to understand these interacting physical phenomena and run a simulation that combined them all, rather than running multiple studies in parallel, was of huge benefit to us,” Gaied concludes. “We’re helping the automotive industry decrease car weight, and making sure that our welds are of high quality and safe for drivers.”



Left to right: Sadok Gaied of ArcelorMittal; Philippe Le Masson, Mickael Courtois, and Muriel Carin of UBS.

“ We’re helping the automotive industry decrease car weight, and making sure that our welds are of high quality and safe for drivers.

– SADOK GAIED, PROJECT MANAGER, ARCELORMITTAL

**References**

<sup>1</sup> M. Courtois, M. Carin, P. Le Masson, S. Gaied, M. Balabane. Guidelines in the experimental validation of a 3D heat and fluid flow model of keyhole laser welding. *Journal of Physics D: Applied Physics* (2016), 49 (15)

<sup>2</sup> M. Courtois, M. Carin, P. Le Masson, S. Gaied, M. Balabane. A new approach to compute multi-reflections of laser beam in a keyhole for heat transfer and fluid flow modeling in laser welding. *Journal of Physics D: Applied Physics* (2013), 46 (50)

# MANIPULATE AND CONTROL SOUND: HOW MATHEMATICAL MODELING SUPPORTS CUTTING-EDGE ACOUSTIC METAMATERIALS RESEARCH

*From consumer audio to ultrasound imaging, the implications of research into metamaterial structures for acoustic cloaking are far-reaching and fascinating. Researchers are using mathematical modeling to design acoustic metamaterials by combining transformation acoustics and highly anisotropic structures.*

By **GEMMA CHURCH AND VALERIO MARRA**

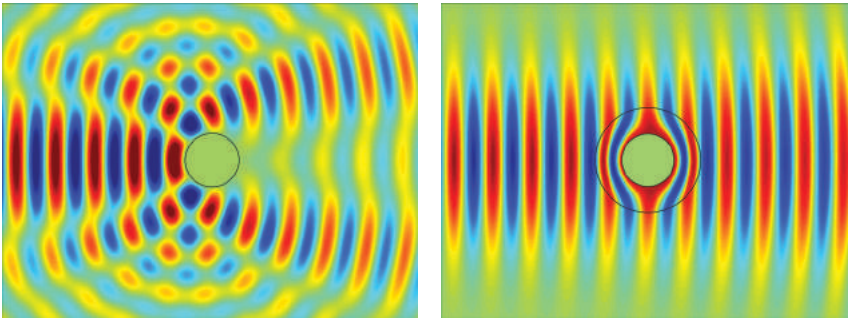

**Figure 1.** Controlling acoustic wave scattering from an object. Left: The scattering of a wave incident from the left from a rigid object is obvious: the reflection is quasi-specular, the shadow is deep, and a portion of wave power is spread in all directions. Right: Surrounding the same object with an ideal cloaking shell shows the absence of both reflection and shadow, while power is transmitted around the metamaterial object with virtually no losses.

**METAMATERIALS ARE MAN-MADE,** specially fabricated materials featuring properties never found in nature, such as zero or even negative refractive index. The result is the creation of cutting-edge designs and functionality, such as superlenses and sound absorbers. Recent research efforts have turned to the arbitrary manipulation of sound waves using metamaterial devices, including making an object acoustically invisible.

The research has been a success. Using little more than a few perforated sheets of plastic and a staggering amount of mathematical modeling and numerical simulation work, engineers at Duke University have demonstrated the world's first 3D acoustic cloak. The device bends sound waves smoothly around an object, fills in the shadow and gives

the impression the waves went straight through the surrounding air.

Acoustic invisibility is just one aspect of the broad concept of transformation acoustics, in which carefully designed materials can deform or control sound waves in almost arbitrary ways. From sci-fi to mundane, there are many possible applications of this technological breakthrough.

## » DESIGNING SILENT METAMATERIALS

**DUKE UNIVERSITY, ALONGSIDE MIT, University of California, Berkeley, Rutgers University, and the University of Texas at Austin,** forms part of a five-year research program sponsored by the US Office of Naval Research to develop new concepts for acoustic metamaterials with effective material parameters that can be fabricated

in the real world. Steve Cummer, professor of electrical and computer engineering at Duke University, said: "Mathematical models are the starting point. The acoustic metamaterial designs are optimized through numerical simulations, which we then translate into modern fabrication techniques and experimentally test."

One focus of the group's current research efforts is on developing acoustic metamaterial structures that can be used in water-based environments, including the human body, to arbitrarily transform and control incoming sound waves. Acoustic cloaking structures (Figure 1) have proven a useful testbed for demonstrating the arbitrary control enabled by transformation acoustics. Designing for aqueous environments represents a shift in metamaterial research, which has evolved from electromagnetic cloaking and transformation optics, to acoustic cloaking and transformations in 2D and then 3D structures in air.

COMSOL Multiphysics® software has been a vital commodity at every stage of the research, going back to the very early days of electromagnetic cloaking. Cummer said: "In the first paper where we showed simulations of electromagnetic cloaking using real electromagnetic material parameters, we used COMSOL® software specifically because it was

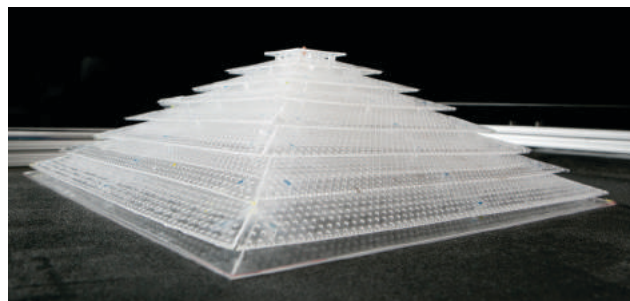
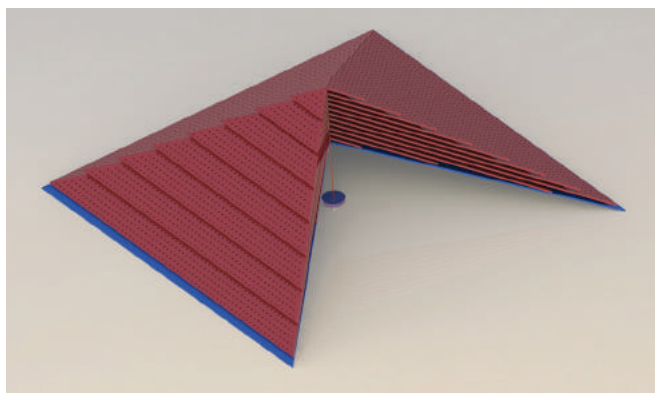

Figure 2. Design (left) and constructed version (right) of the pyramid-shaped 3D acoustic cloaking shell.

one of the only electromagnetic software tools that had the ability to accommodate arbitrarily anisotropic electromagnetic material parameters.”

To attack the acoustics problem, the researchers began with deriving the needed material properties. Cummer explained: “To arbitrarily control sound using transformation acoustics, we first apply a coordinate transformation to describe how you would like to bend or twist or deform the sound field in a particular device. Once you’ve defined that coordinate transformation, then you can derive the effective material parameters you need to create that particular deformation of the sound field.”

That resulting set of material parameters is almost always anisotropic, which means the material properties behave differently in different directions. To handle this the researchers needed to be able to change the equations representing the physics being simulated. “COMSOL makes it so easy and relatively straightforward to manipulate the material properties and the underlying dynamic equations. This was really important because we could add that one extra twist of the anisotropy to the model and start simulating some of the designs that we were exploring within the transformation acoustics approach,” Cummer added.

The resulting real-world designs have been very successful and their performance matched the simulations “astonishingly well”, according to

“COMSOL makes it so easy and relatively straightforward to manipulate the material properties and the underlying dynamic equations.

— STEVE CUMMER, ELECTRICAL AND COMPUTER ENGINEERING DEPARTMENT, DUKE UNIVERSITY

Cummer. “The gold standard in metamaterials publications these days, to show whether a structure works the way you want it to and produces the physics you want it to, is to take a measurement of the full sound field produced by the acoustic metamaterial and compare that to the simulation,” he added.

COMSOL Multiphysics® software is able to consistently achieve such agreement, even when human error has tried to derail the research. In

an earlier project, a 2D acoustic cloaking shell featuring a series of tiny holes was designed and built, but the experiments did not match the simulations. The team was flummoxed and could not see any viable reason for the discrepancy. They suddenly realized that holes in the structure were the wrong size due to a mix up during its construction.

Cummer said: “The efficiency of COMSOL has been pretty critical in our work because we can do

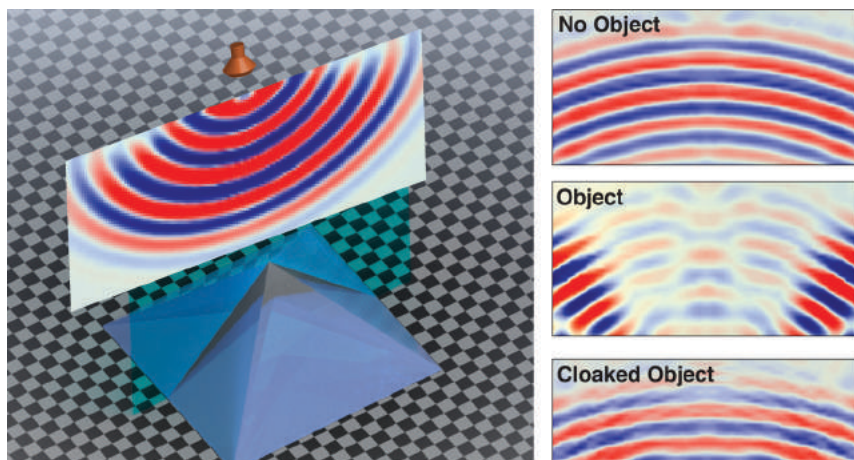

Figure 3. (left) To test the metamaterial shell, a sound pulse is launched in three different configurations and the reflected sound pulse is measured with a scanned microphone. (right) The reflected acoustic pulse from the test object is dramatically different than that with no object. When the cloaking shell is placed on the object, the reflected pulse is almost identical to that with no object, demonstrating its invisibility to sound.

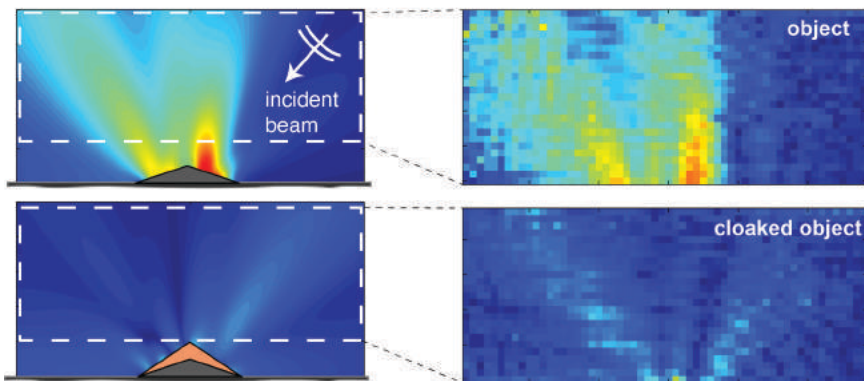

Figure 4. The good agreement between simulations (left) and measurements (right) of the scattered acoustic fields not only shows the degree of acoustic cloaking of the object, but confirms that COMSOL accurately predicts the performance of the fabricated device.

numerical simulations of both the idealized parameters and then of the full structure that we would actually build, to confirm that they behave the same way.”

### » FABRICATING AND TESTING AN ACOUSTIC METAMATERIAL

**THE DESIGN OF A 3D ACOUSTIC CLOAKING** shell employed the same basic perforated plate structure in a pyramidal shape (Figure 2) under which an object could be hidden from sound waves. The structure may at first appear to be relatively simple in its design, but many factors are balanced to achieve the desired acoustic transformation, including the hole diameter, the spacing between the plates, and the angle of the plates. All of these parameters combine to give just the right amount of acoustic anisotropy to make the structure work.

This pyramid structure was the world’s first 3D acoustic cloak, and laboratory measurements confirmed that it is capable of rerouting sound waves to create the impression that both the cloak and anything beneath it are not there (Figure 3). The device works in all three dimensions, no matter which direction the sound is coming from or where the observer is located, and holds potential for future applications such as sonar avoidance and architectural acoustics.

Given the necessary thickness of the acoustic metamaterial shell, the latter is the more plausible option, where such acoustic cloaking devices could be used to optimize the sound in a

concert hall or dampen it in a noisy restaurant environment, for example. Cummer said: “The cloaking material is not just magic paint you can spray onto something. Generally speaking, that’s not the way that these kind of ideas can be deployed in practice.”

Beyond the design stage, modeling and simulation have been used to predict the quantitative performance of metamaterial shells like this, including a detailed analysis of the scattering from a 2D cloaking shell implementation (Figure 4). Not only does this show how much the scattered field is reduced by the shell, but COMSOL accurately predicts the amount of scattering reduction given design tradeoffs made in the fabrication of the acoustic metamaterial.

### » FROM AIR TO WATER: DIFFERENT MEDIUM, NEW CHALLENGES

**ATTENTION HAS NOW SHIFTED** to getting acoustic metamaterials to work in an aqueous environment, such as underwater or inside the human body. Multiphysics modeling is used as the primary design tool to first map the previously designed structures and run simulations in order to test how they will perform in water. The move from air to water is more difficult than it sounds.

The problem is that the mechanical properties of air are dramatically

different from those of water. Cummer explained: “That’s why in air we can get away with building acoustic metamaterials in plastic, or whatever solid is convenient, as the solid can act essentially as a perfectly rigid structure to control the sound field flow. It doesn’t really matter what it is made of.”

But the mass density and compressional stiffness of water are not so different from solid materials. “When sound waves hit a solid structure in water, the mechanical properties of that solid start to matter a lot. We need to come up with new techniques in the design phase to be able to control how that sound wave energy interacts with the solid so that we can maintain the properties we want,” he added.

“The ability to easily merge acoustics and structural mechanics is essential, especially when we’re dealing with structures in water where we can’t ignore the mechanical responses of the solid material that we’re using to build the metamaterial. In airborne acoustics, we can get away with treating the solid as a material that is infinitely rigid, which is easy and computationally efficient, but for the water-based material it is essential to be able to consider fluid-structure interaction, which is easy with COMSOL.”

The leap from research into commercially viable acoustic metamaterial structures is far from simple and means such structures must be able to be fabricated reliably and repeatably. Cummer concluded: “The next step to creating any acoustic metamaterial is that it is able to hit specific quantitative metrics. That means we have a more complicated design process, but that’s exactly what COMSOL is designed to do. [It allows] much more design iteration and clever use of optimization to identify degrees of freedom in the design that can be manipulated to then hit those specific numerical targets. That’s definitely the key going forward in transitioning these ideas from proof of concept demonstrations to something that’s actually practical and deployable in the real world.” ©

# VIRTUALLY TUNING AN AUTOMOTIVE AUDIO SYSTEM

*Experts at HARMAN are using physical experiments in conjunction with mathematical modeling and numerical simulation to improve the development process for the latest vehicle infotainment technology.*

By **LEXI CARVER**

## TODAY'S VEHICLES OFFER DAZZLING

electronic entertainment possibilities, from smartphone connectivity to interactive displays and video screens. HARMAN is the market leader in these connected car setups, equipping more than 80% of the world's luxury cars with premium audio systems.

Each vehicle model requires a unique configuration, and HARMAN's team of acoustic and simulation specialists ensure that different components and car acoustics are accounted for in their design process. Details such as the ideal placement and orientation of speakers, speaker packaging, and driver enclosure geometry such as car doors all influence the sound quality.

The team uses physical experiments in conjunction with numerical analysis to accelerate product development by virtually "tuning" their systems before ever creating a live prototype. This saves time on physical testing, and allows virtual tests to replace in situ listening, so that the team can design their products even before



Figure 1. Loudspeaker positioning in the vehicle interior.

the final car designs are complete.

"We may become involved very early in the car development process, when a vehicle designer has not yet decided what is required from the audio system," explains Michael Strauss, senior manager of Virtual Product Development and Tools (VPD) at HARMAN. "Or we may only have basic details such as the size and volume of the car cabin. Yet frequently we need to present a concept within a few days, creating a tricky challenge to meet our clients' requirements and deliver high-quality systems."

## » SIMULATION AND EXPERIMENTS TEAM UP FOR CUSTOMER SATISFACTION

**TO PROVIDE CUSTOMERS** with a response that is both quick and accurate, engineers at HARMAN turn to mathematical modeling in COMSOL Multiphysics® software. "We needed capabilities for mechanical, acoustic, and electrical simulations in one integrated environment, and we wanted a program that would free up the time and effort spent on creating and updating our own tools," says François Malbos, senior acoustics engineer at HARMAN.

"The multiphysics approach is one of the most important parts of the virtual product development process," says Michał Bogdanski, project leader in virtual product development at HARMAN. "We can explore how the acoustic behavior of a loudspeaker relates to any part of a vehicle structure — for example the stiffness of a door — and then provide design guidelines to our customer."

In one case, they both measured and simulated the sound pressure levels generated by a loudspeaker in the cabin of a Mercedes-Benz ML car (see Figure 1) in order to validate their numerical models and later use them to optimize acoustic equipment. "Car cabin simulations are among the most challenging to run because they cover many different areas of physics," explains Strauss. Fortunately, COMSOL® software offers options to couple together the acoustic, mechanical, and electrical effects throughout the system.

To support companywide engineering efforts, Strauss' team established a library of validated models and known solutions that allows for performance predictions of a wide variety of loudspeaker configurations. "We are able to offer everything from a high-level trend analysis to a detailed design examining the performance of a subsystem," he continues.

## » ANALYZING VEHICLE LOUSPEAKER PERFORMANCE

**IN ONE STUDY, ENGINEERS AT HARMAN** used COMSOL to create a simulation of a car cabin's sound system in order to optimize the speaker acoustics, specifically for low-frequency soundwaves. They then designed a series of tests to validate the model. Once validated, the model would allow the HARMAN team to deduce the best loudspeaker setup for a given car.

In validation tests, a loudspeaker

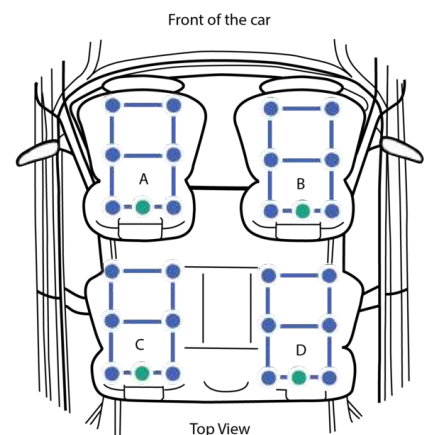

Figure 2. Top view of the microphone arrays positioned at four different locations.





Figure 3. HARMAN's 3D scan of the car cabin.

was mounted on a rigid enclosure near the driver's seat of the car. Four sets of microphone arrays throughout the cabin served to measure average sound pressure levels at each location (see Figure 2).

For frequencies below 1 kHz, the loudspeaker was represented as a rigid flat piston tied to a simplified lumped parameter model (LPM) taking into account the voltage at the voice coil terminals and the stiffness of the suspension and speaker membrane surface. The geometry was generated from a manual 3D scan (see Figure 3). Using a preprocessing algorithm implemented in MATLAB® software and an add-on product to COMSOL® called LiveLink™ for MATLAB® that creates a bidirectional link between the two programs, the team converted the point cloud created by the scan into a surface mesh of the car cabin (see Figure 4) and created an optimized mesh for studying acoustic pressure waves.

The simulation analyzed the interaction of the sound waves generated by a speaker with the different materials of the windshield, floor, seats, headrests, steering wheel, and other sections of the car such as the roof, doors, and instrument panels, each of which have different absorption properties.

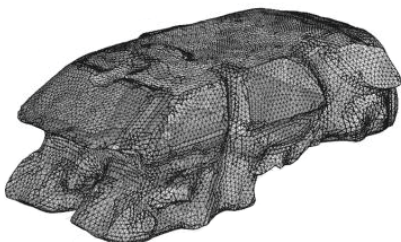

Figure 4. Surface mesh of the car cabin.

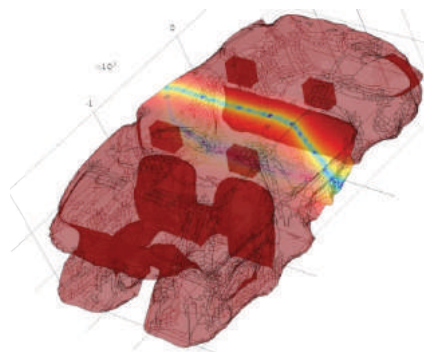
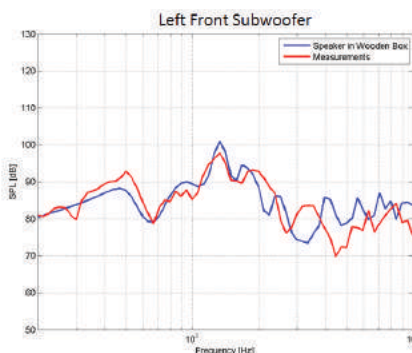

Figure 5. Sound pressure levels for one microphone array (left) and throughout the cabin (right).

### » OPTIMIZING THE ACOUSTIC MODEL

IN ADDITION TO ACCOUNTING for many different materials, the team also defined speaker membrane motion and acceleration based on the volume of the enclosure using LiveLink™ for MATLAB®, and developed special MATLAB® software scripts to simplify the preprocessing and postprocessing activities.

“Everything is fully optimized and automatic so that we do not have to calculate the acceleration for each case; when one simulation finishes, the next launches,” explains Bogdanski. “This ensures that the whole process is easy and error-free; we simply let the scripts run.”

The team also optimized the frequency-dependent absorption coefficients necessary to achieve a strong correlation between the measured and simulated sound pressures. The analysis then provided the sound pressure levels emanating from each microphone array (see Figure 5).

### » VIRTUAL TUNING TAKES A NEW TURN

AS A RESULT of their validated simulations, HARMAN is able to start developing a sound system even as a vehicle is still being designed. Only when the car is ready for test-driving does an acoustics engineer need to get into the car to fine-tune the audio. They're now setting up a playback system that will, “based on simulation results and signal processing, allow the

user to listen, evaluate, and compare any optimized audio system including subwoofers, midranges, and tweeters,” says Malbos. “Design modifications are done much quicker in the virtual domain than rebuilding a real prototype.” Listening tests demonstrate that this scientific approach can successfully replace in situ listening.

The ability to assess an audio system based purely on simulation is increasing the quality and speed of the product development process at HARMAN, improving customer responsiveness, and lowering the cost of design amendments, thus creating more sense of design freedom for the engineers.

“The beauty of simulation is that a systems engineer can sit at a desk, put headphones on and begin to tune a system without the car. Using simulation we can assess, optimize and predict the performance of a proposed sound system, even though it does not actually exist yet,” says Strauss. ©



The HARMAN VPD team consists of François Malbos, Michael Strauss, and Michał Bogdański.

# DESIGNING ENERGY-EFFICIENT PHOTONIC SWITCHES TO SUPPORT GROWING NETWORK TRAFFIC

*Thermo-optic silicon photonic switches are under development at Huawei Technologies Canada for the communications and high-performance computing industries. Design optimization via numerical analysis aims to minimize power consumption and maximize switching speed.*

By **JENNIFER SEGUI**

**ALL-OPTICAL NETWORKS WERE ENVISIONED DECADES AGO** because of their potential for high transmission speeds to address the ever-increasing demands on network performance. Photonic switches are already widely deployed throughout cities and long-distance networks, while experiments in data centers and high performance computing are ongoing. Huawei Technologies Canada is radically improving critical optical components, such as

photonic switches, using silicon photonics (SiPh).

Optical networks use waves of light to transmit data, for example, when a phone call is placed or a search request or email is handled. To route the data

at various points in the network, the optical signal is traditionally converted back to an electrical and then converted again to an optical signal as shown in Figure 1. Converting the signal uses large, power-hungry equipment, which adds latency while each packet is converted. In comparison, photonic switches do not convert the signal format. Hence photonic switches are often faster, smaller, and more energy efficient.

Existing photonic switches, however, are bulky and expensive, and are made of many hand-assembled components. To address the issue, Huawei is developing circuits using integrated SiPh technology. Optical circuits are made in CMOS chip foundries with silicon waveguides about 0.5 micrometers across, which is possible because silicon is transparent at the signal wavelengths.

At Huawei, they are prototyping some of the most complex silicon photonic circuits in the world, relying on an integrated design environment. Highly accurate numerical physics models are fine-tuned through iterative prototyping cycles, while photonic circuit layout software ensures first-time-right chip design. The thermal performance of the thermo-optic SiPh switch is a core part of this design workflow.

**» ROUTING DATA WITH THERMO-OPTIC SWITCHES BASED ON PHASE SHIFT**  
THE THERMO-OPTIC SWITCH under development is a silicon photonic Mach-Zehnder (MZ) interferometer, which has a

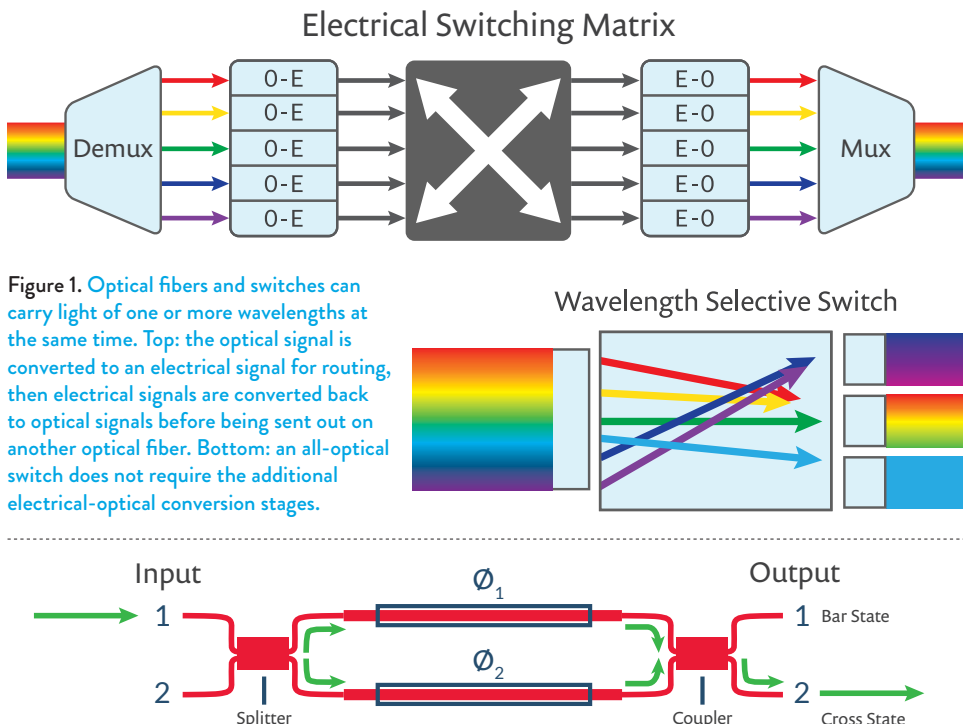
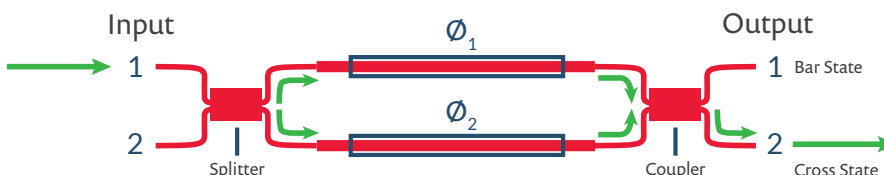
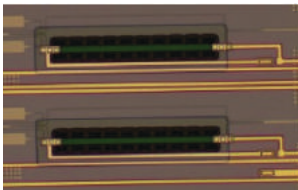
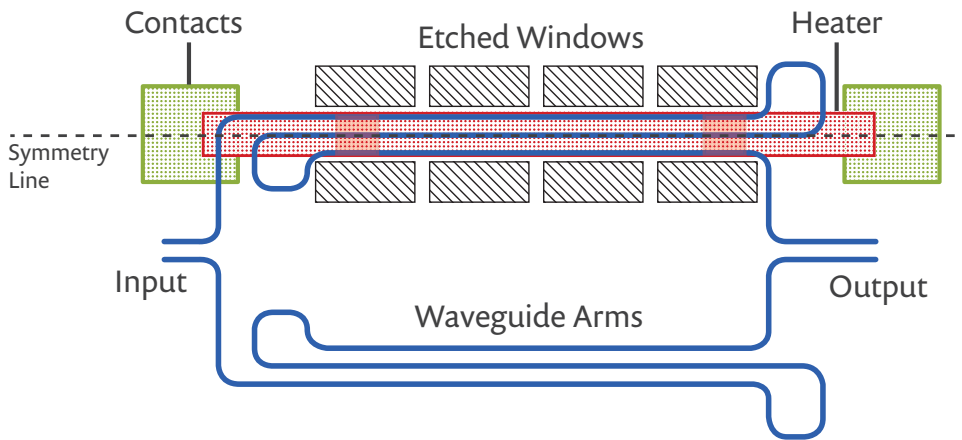

Figure 1. Optical fibers and switches can carry light of one or more wavelengths at the same time. Top: the optical signal is converted to an electrical signal for routing, then electrical signals are converted back to optical signals before being sent out on another optical fiber. Bottom: an all-optical switch does not require the additional electrical-optical conversion stages.

Figure 2. In a Mach-Zehnder interferometer, light entering an input waveguide is split onto two arms, where the waves will experience a phase shift depending on the optical properties of each arm. At the output, the coupled waves will undergo constructive and destructive interference representing the cross and bar states of an optical switch. The path in green shows the default switch state.





**Figure 3.** Diagram of a thermo-optic Mach-Zehnder phase shifter with thermal undercut, at top, where a resistive heater (pink) located above one of the waveguide arms (blue) is used to change the index of refraction causing a phase shift in the propagating light wave. The photo at bottom shows the heated waveguide as fabricated.

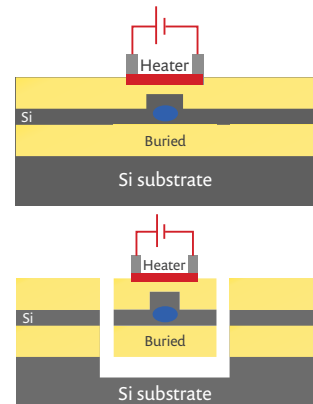

**Figure 4.** Cross-sectional view of the heated waveguide arm of a thermo-optic Mach Zehnder switch without (top) and with (bottom) thermal undercut. The thermal undercut isolates the waveguide and heater reducing wasteful heat transfer to the surrounding material.

cross state and a bar state. By default, the MZ shown in Figure 2 is in the cross state. A light wave arriving at an input (e.g. input 1) is split and travels along both arms. The light from the two arms interferes at the output coupler. Because of the relative phase of the light from the two arms, all of the light comes out of output 2.

A thermally induced phase shift provides a way to flip the switch state. To switch a thermo-optic MZ to its bar state, one arm of the MZ is heated. This changes the refractive index of the waveguide, creating a  $\pi$  phase shift in the light propagating in that arm. Interference causes the light to come out of output 1, carrying data toward a different destination. By combining a large number of these switch cells on one chip, a large switch matrix is created.

The MZ switch design implemented by Huawei is presented in Figure 3, where light enters the

switch and is divided between the two folded waveguide arms, which are represented by blue lines. Above one arm is a titanium nitride (TiN) resistive heater, indicated by the pink shaded region in the figure. Applying a voltage to the electrical contacts causes the heater to increase the temperature of the underlying waveguide to produce a  $\pi$  phase shift, which changes the switch state. The triple-folded waveguide increases the interaction length between the heater and waveguide, thus improving the efficiency by a factor of three.

The heated waveguide arm of the thermo-optic switch in Figure 3 is a suspended structure, where the surrounding cladding material is etched away, forming a thermal undercut. A cross-sectional view of the waveguide with and without thermal undercut is shown in Figure 4. The thermal undercut

prevents heat conduction to the underlying substrate, allowing the heater to raise the temperature of the buried waveguide 23 times more efficiently, and therefore consume 96 percent less power.

### » THERMAL ANALYSIS AND DESIGN OPTIMIZATION

**THE REQUIREMENTS ON POWER** consumption, switching speed, and physical size, together with the manufacturing design rules of the thermal undercut, combine to create a significant optimization problem for the implementation of

thermo-optic MZ switches. To arrive at a final design, thermal analysis in COMSOL Multiphysics® software provides an efficient means to quantitatively evaluate new designs before manufacturing physical prototypes.

“Our move toward large-scale product development demands thorough optimization work, where every mW of power consumption counts,” says Dritan Celso, a senior research engineer at Huawei. Therefore, COMSOL® software was added to the integrated design environment for

“ Our move toward large-scale product development demands thorough optimization work, where every milliwatt of power consumption counts.

—DRITAN CELO, SENIOR RESEARCH ENGINEER, HUAWEI

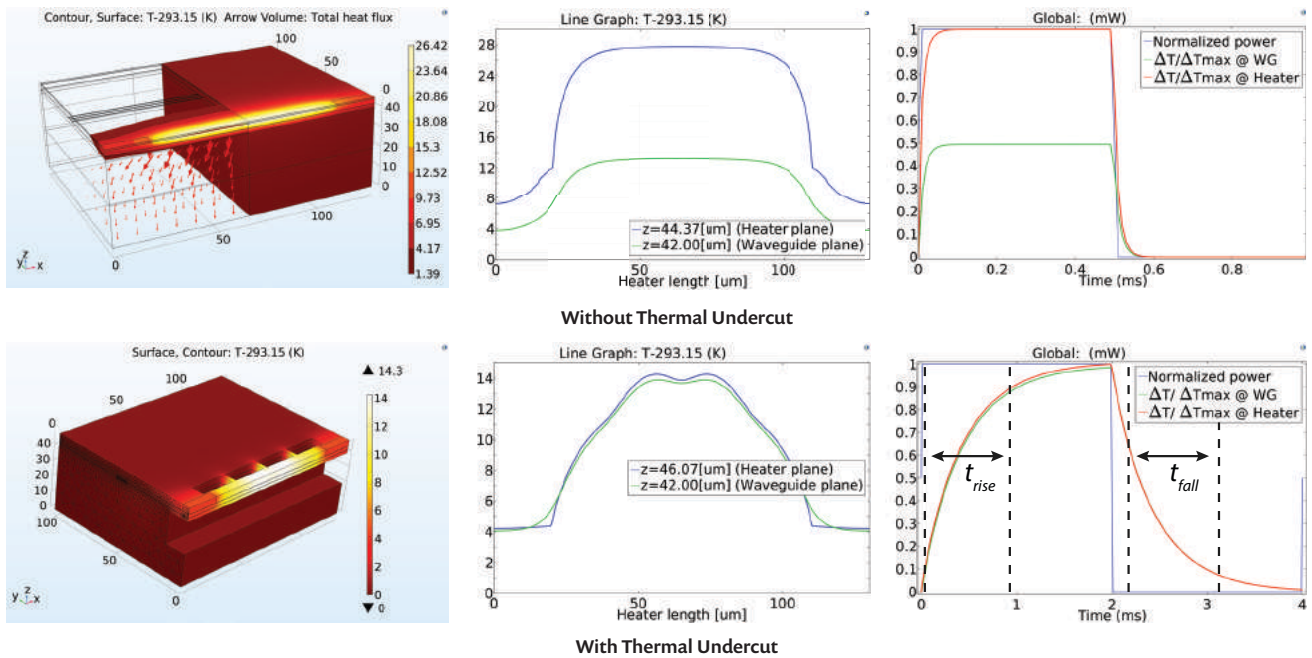

Figure 5. COMSOL Multiphysics® software model of a thermo-optic switch without (top) and with (bottom) thermal undercut. Plots show the steady state temperature distribution (left), temperature difference between heater and waveguide (middle), and transient analysis indicating time required for the waveguide to reach target temperature (right).

silicon photonic devices. For example, thermal analysis is used to quantify the performance of different thermo-optic designs, both with and without thermal undercut, which is an important consideration since undercut adds additional steps to the manufacturing process. Additionally, while using a thermal undercut can improve the energy efficiency of a device, there is a decrease in switching speed, hence a device geometry with undercut is suited only for certain applications. The device geometry shown in Figure 3 was implemented in COMSOL® software, both with and without using a thermal undercut. To reduce the computation time required for steady state thermal analysis of each design,

half symmetry was used as indicated by the dashed black line in Figure 3, and the resulting model geometry is shown at left in Figure 5. Silicon waveguides that are 100s of micrometers in length are buried in silica glass on top of a silicon substrate. Material properties assigned to each domain in the model were chosen from options that are already available in the software. Since SiPh structures have high-aspect ratios of 1000:1, COMSOL Multiphysics® meshing algorithms were critical for fast and accurate modeling. Heat transfer in solids is modeled throughout the device geometry, with insulating boundary conditions defined on the surface passivation layer and thermal undercut boundaries when present.

The titanium nitride heater in the heated waveguide arm is defined as the heat source in the switch model, and simulation results reveal how much applied thermal power is required to produce a  $\pi$  phase shift for a given design. To produce a  $\pi$  phase shift, the waveguide temperature must change by 13.3 Kelvin, which is a value determined from optical test measurements. Steady state analysis of the thermo-optic SiPh switch demonstrates a 23x reduction in the amount of power required to achieve a  $\pi$  phase shift when a thermal undercut is included in the design. The temperature distribution is shown at left in Figure 5 for each device geometry. The plots in the middle depict the temperature difference between the heater and waveguide, demonstrating the extent of heat loss to the surrounding materials in devices without undercut.

A difference of 0.2 Kelvin was achieved in the design with undercut, compared to a 13 Kelvin difference without. Transient analysis, using quarter symmetry to further reduce computation time, provides information on how long it takes to tune the waveguide to the desired temperature and phase, which limits the cross/bar switching speed of the device. Although devices with undercut are more energy efficient, they do not tune as quickly as devices without undercut, as demonstrated by the rise and fall times at right in Figure 5. The validated steady state and transient models are also critical for evaluating the thickness of the silica glass, overall size of an individual MZ switch, and effect of a cooling passivation layer on top of the device, thus enabling an application to maximally benefit from reduced power consumption.

## » PACKING THOUSANDS OF SWITCHES ONTO A SINGLE CHIP

ALTHOUGH THE FOCUS of the heat transfer simulations is to optimize a single thermo-optic MZ switch, in actual practice, they are not found alone, but used in large switching matrices as shown in Figure 6. Huawei's matrix is designed to prevent optical crosstalk, which ensures that the

optical signals out of the switch are very clean. The architecture at left in Figure 6 represents a 32x32 SiPh switch matrix containing 448 2x2 thermo-optic MZ switch cells. A light path passes through one cell in each column, and the path is defined by applying the appropriate cross or bar drive power to those cells. Supplying power to a switch raises the underlying waveguide temperate and

generates the necessary  $\pi$  phase shift that allows a signal to propagate along a chosen path.

A fabricated prototype of the 32x32 switch matrix is shown at right in Figure 6, and was produced at a CMOS foundry that specializes in the manufacture of SiPh devices, including the thermal undercut technique. The prototype also includes on-chip monitor photodiodes for each cell to determine the cross/bar drive current, and represents an important advance in their work.

Entering the prototyping and large-scale product development phase opens up new challenges, which require designers to divide

their time between the R&D facilities at Huawei and the foundry. "Thermal performance is a small, but important piece of the very large puzzle that represents the device design workflow," explains Celso. "Looking toward large-scale product development, fabricating a 128x128 SiPh switch with thousands of MZ cells on a single die that consumes no more than 50 watts of power, which may be used in many different environments, raises questions about mechanical stability. Structural analysis of the packaged switch has now become a focus, and numerical simulation in COMSOL® software will again prove useful to optimize its design." ©

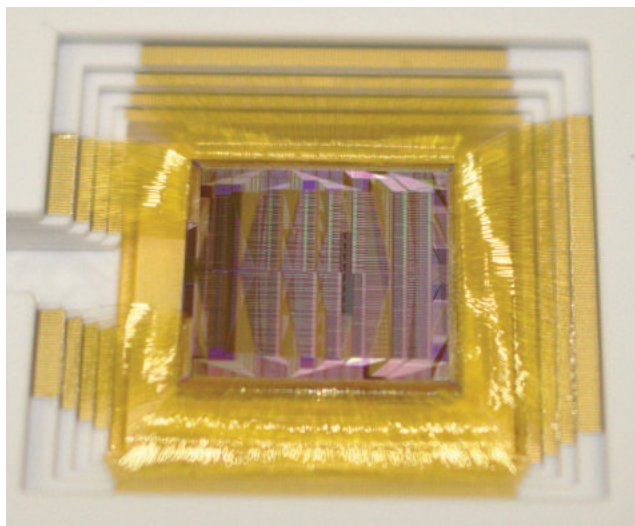
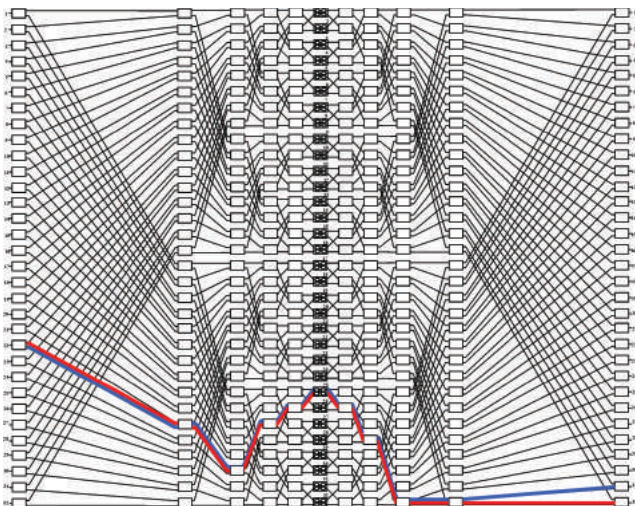
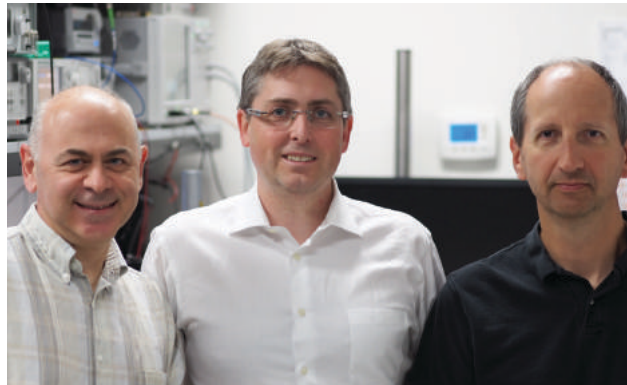

Figure 6. A 32x32 switch matrix with 448 2x2 thermo-optic MZ cells (top), and the fabricated prototype with on-chip monitor photodiodes with each cell (bottom).



Dritan Celso, Eric Bernier and Dominic Goodwill from the Huawei Technologies Canada advanced photonics team.

## References

D. Celso, D. J. Goodwill, J. Jiang, P. Dumais, C. Zhang, F. Zhao, X. Tu, C. Zhang, S. Yan, J. He, M. Li, W. Liu, Y. Wei, D. Geng, H. Mehroar, E. Bernier. *32x32 Silicon Photonic Switch*, presented at *Optoelectronics and Communications Conference/International Conference on Photonics in Switching, Niigata, Japan 2016*.

D. Celso, D. J. Goodwill, J. Jiang, P. Dumais, M. Li, E. Bernier. *Thermo-optic silicon photonics with low power and extreme resilience to over-drive*, presented at *IEEE Optical Interconnects Conference, San Diego, CA 2016*. DOI: 10.1109/OIC.2016.7482994, IEEE.

# OUR 5G FUTURE: IN THE FAST LANE WITH NUMERICAL SIMULATION

By JIYOUN MUNN

**5G AND THE INTERNET OF THINGS (IOT)** are among the hottest topics being discussed in the radio frequency (RF) and microwave industry. Everyday activities and technological advancements depend more than ever on reliable and fast data communication. Designers are now faced with one their biggest challenges as they need to bring real-time data usage and availability to the next level, which requires access to the best design tools and significant advances in signal processing, device-centered communications, and evolving technical standards.

## » FROM 4G LTE TO 5G

**IT'S EXPECTED THAT 5G WILL NEED** to utilize higher frequency spectrums in the millimeter wave range when deploying active electronically scanned arrays (AESA), which enable multi-beam multiplexing and massive multi-input-output (MIMO) technologies (Figure 1). Researchers working on the frontlines of forging this ultra-fast and high bandwidth successor to 4G LTE are relying on modeling and simulation tools to optimize product development and test cycles.

Simulation supports designers throughout the design cycle by allowing them to virtually evaluate several design ideas and implement physical prototypes based on the most promising concepts. Another advantage consists in the possibility to investigate different boundary conditions: in this case simulation allows an engineer to efficiently measure and test several scenarios without damaging a prototype, in cases such as extreme temperature variation, structural deformation, and chemical reactions. The goal of simulation specialists is to mimic the real world as closely as possible, so that the prototype is based on numerical results that achieve the expected performance in fewer design and test iterations.

## » DESIGNERS JOIN FORCES WITH SIMULATION SPECIALISTS THROUGH APPS

**IN PREPARATION FOR THE 5G ROLLOUT**, designers are working through a number of obstacles, including frequency choices, propagation, reliability, battery life, and interference, to name a few. Each of these challenges is represented by a unique blend of physics that require a simulation specialist in that specific area who is equipped with the right tools to set up the underlying mathematical model properly. The symbiosis between designers and simulation specialists needs to be perfect in order to deliver the right product at the right time.

Simulation experts are typically the only ones who can

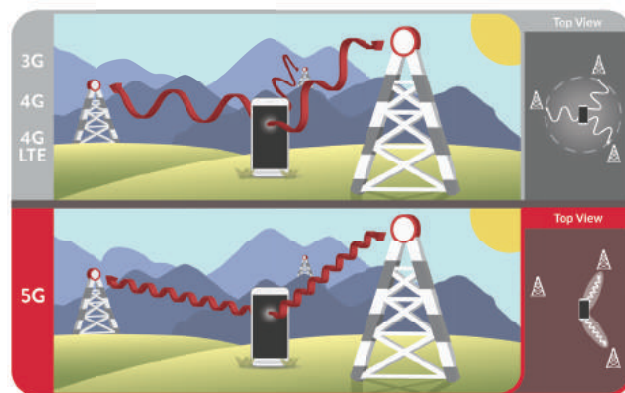

Figure 1. Isotropic radiation pattern was preferred before the 5G era (top). Antennas generating a higher gain (directivity) radiation pattern are required for 5G millimeter wave communication to compensate for the path loss in free space (bottom).

safely provide the input data needed to get a useful output from a model. They therefore have to be involved in the iteration process every time there is a new request or change to be made in the device being simulated. Additionally, results or outputs are often presented in an environment only familiar to the specialist, so distributing the information to their colleagues often requires a meeting to present an explanation and interpretation of the results.

But what if simulation specialists could easily build simulation apps, i.e. wrap an intuitive interactive user interface around a complex mathematical model? What if users without any previous experience using simulation

software could run apps specifically designed just for them? Simulation apps make it possible for simulation specialists to efficiently and effectively support the designers relentlessly working on the next breakthrough in the ultra-competitive landscape of wireless communication. Supplied with the right tools, designers working on 5G implementation can freely collaborate and complement their skills with those of their colleagues and collaborators who specialize in physics and numerical analysis.

## » WHAT SIMULATION APPS CAN DO FOR WIRELESS COMMUNICATION DESIGN

**LET'S TAKE THE EXAMPLE** of active electronically scanned arrays, or phase antenna arrays. They have become popular for military use in radar and satellite applications and are now occupying a conspicuous position for commercial purposes due to the growing

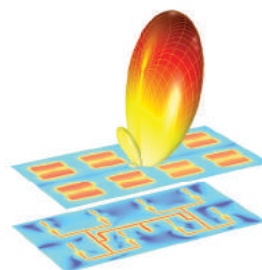

Figure 2. 2x2 phased microstrip patch antenna modeled using COMSOL Multiphysics® software. The top plot shows the logarithmic electric field norm on the patch and the 3D far-field radiation pattern. The lower plot depicts the logarithmic electric field norm on feed line planes.

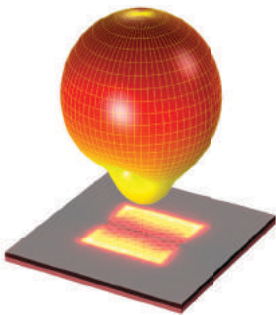

Figure 3. Single patch antenna. Logarithmic electric field norm on patch, mesh, and 3D far-field radiation pattern are visualized.

needs of higher data rates in communication devices. The size of a simple component can easily exceed tens of wavelengths, making its numerical analysis very memory intensive. As a result, models take a very long time even when approximated values would be sufficient to evaluate a proof-of-concept design. Fast prototyping would help to reveal performance tendencies and determine design parameters quickly.

Figure 2 shows a simulation of a 4x2 phased microstrip patch antenna array which can steer the beam in the desired direction. This example is significantly more memory intensive and will take a longer time to compute than a single microstrip patch antenna (Figure 3).

Results shown in Figure 3 are based on a full finite element method (FEM) model of a single slot-coupled microstrip patch antenna built on low-temperature co-fired ceramic (LTCC) layers, initially operating at 30 GHz.

Can we use the analysis of a single antenna to describe the behavior of the entire array? The power and flexibility of COMSOL Multiphysics® software allow simulation

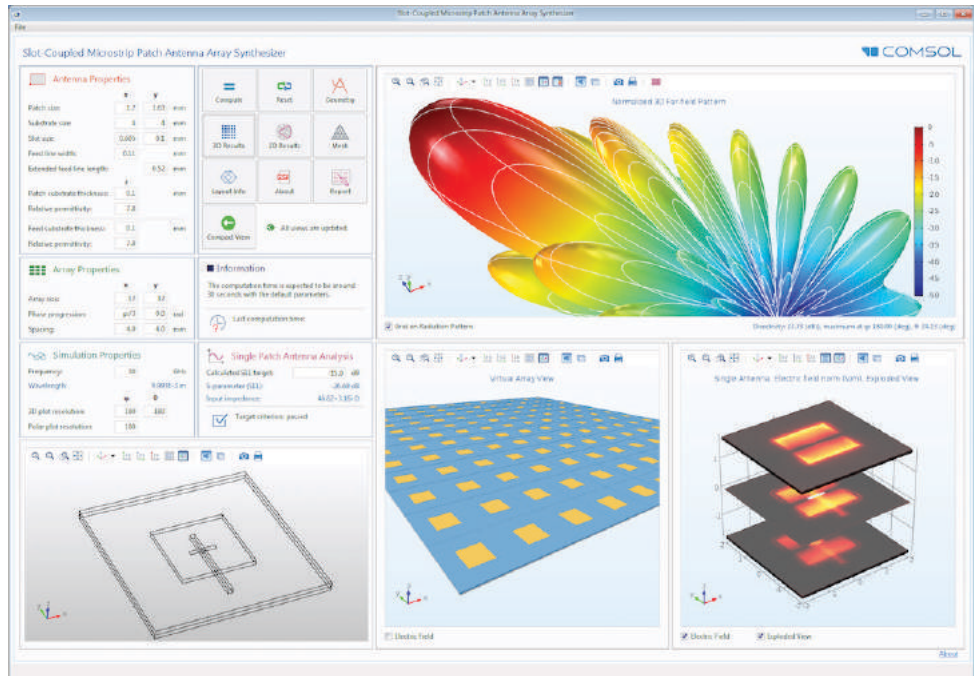

Figure 4. The user interface of the Slot-Coupled Microstrip Patch Antenna Array Synthesizer simulation app built using the Application Builder tool available in COMSOL Multiphysics.

specialists to perform an accurate simulation of a single microstrip patch antenna and then take into account user inputs such as array size, arithmetic phase progression, and angular resolution to describe, for example, the 3D far-field of the entire array. COMSOL makes it easy for specialists to couple physics interfaces already available with equations or algorithms needed to model a specific application.

In this case, the two-dimensional antenna array factor has been implemented to include the translational phase shifts and array element weighting coefficients needed to determine the radiation pattern of the entire array.

Can we present such a model to designers in a user-friendly way? Simulation specialists are now provided with an intuitive workflow to create custom user interfaces based on their multiphysics simulation

model. An app built for simulating the antenna array we just discussed is shown in Figure 4.

This app allows the designer to change the physical size of the single microstrip patch antenna as well as the thickness and material properties of each layer, in addition to other relevant parameters determined by the simulation specialist. In this particular example, the simulation specialist has included an interactive user experience by indicating whether the chosen design parameters are appropriate or not by comparing the computed S-parameter ( $S_{11}$ ) value to the pass/fail target criterion. This app also includes a results report and documentation that concisely explains how the app is working. This last feature can be used

in a variety of practical ways, from building reports for stakeholders and management, to use as a training tool for new hires in the company.

Apps can also be easily deployed to colleagues and collaborators through a local installation of the COMSOL Server™ product, which allows authorized users to access apps through COMSOL Client or a major web browser.

We have a lot of work ahead of us before 5G is unveiled to the public. When designers are equipped with the right set of tools, they can freely collaborate with colleagues throughout their organization and beyond. Working cross-departmentally will be key to competing and succeeding in the 5G race. ☺

# LET THERE BE LIGHT: A BRIGHTER FUTURE FOR OLEDS

*Surface plasmon modeling and nanostructured electrode design show promise for increased light output and efficiency in organic LED (OLED) systems.*

By **LEXI CARVER**

**ALTHOUGH IT'S BEEN NEARLY** a century and a half since Thomas Edison flipped a switch to turn on the world's first practical light bulb, the search for better light sources continues unabated. Many other lighting technologies have been developed since that day in 1879, bringing features such as brightness, color quality, dimming capability, and low life-cycle costs.

Organic LEDs, or OLEDs, are attracting strong interest because they can be used in lightweight, paper-thin, light-emitting panels in a variety of shapes and sizes. They can be used to create flexible or bendable lighting devices applied to a flat or curved surface area to build parts such as car tail lights and even "lighting flowers" (see Figure 1).

But OLEDs aren't nearly as bright or as energy-efficient as their inorganic cousins, LEDs, and so researchers at Konica Minolta, Inc. are racing to develop designs to meet growing demand. The company is a world leader in OLEDs that supports the development of cutting-edge devices for imaging and optics, often working in partnership with Japan's leading universities.

Leiming Wang is a senior researcher

at the Konica Minolta Laboratory USA in San Mateo, CA, working with a team that uses numerical simulation to analyze light-loss mechanisms in OLEDs to virtually test ways to improve designs. "Despite all their advantages, OLEDs suffer from a number of limitations we are working to minimize," he said. "Most impactful is a complex plasmon coupling phenomenon accounting for 40% of the light lost through interactions within the device."

## » HOW OLEDS WORK

**OLEDs ARE COMPOSED** of organic semiconductors sandwiched between positive (anode) and negative (cathode) electrodes. Figure 2 shows the layout of an OLED device, with an anode made of transparent indium tin oxide (ITO), three organic layers — a hole transport layer (HTL), emitting layer (EML), and electron transport layer (ETL) — and a silver cathode. These are all fabricated on a glass substrate, which light passes through when the device is turned on.

When current is applied, electrons are injected at the cathode and holes at the anode. Electrons and holes travel toward each other through the layers, combining in the emissive



Figure 1. Huis Ten Bosch is a theme park in Sasebo, Nagasaki Prefecture, Japan, designed to look like the Netherlands. Konica Minolta developed "OLED tulips" in collaboration with the park for use in its tulip festival.

layer to release energy in the form of photons. This happens quickly while current is flowing, causing a stream of continuous light.

## » CATCHING THE PHOTON THIEVES

**BUT SOME PHOTONS NEVER** make it to the outside world. Light losses in an OLED can occur through several mechanisms, such as differences in the refractive indices of each layer that can cause light to reflect within the layers rather than traveling outward, as Figure 2 depicts.

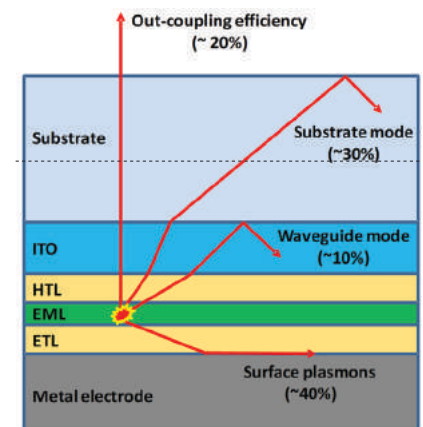

Figure 2. Schematic of a multilayer OLED structure showing various types of light losses.



**“** We could understand the breakdown of loss mechanisms, easily test the influence of different design constraints, and adjust our OLEDs accordingly. COMSOL has shown us how to cut these plasmon losses in half.

— **LEIMING WANG, SENIOR RESEARCHER, KONICA MINOLTA**



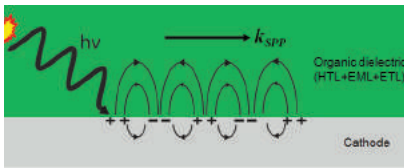

Figure 3. Schematic showing surface plasmons coupling with dipole radiation in the OLED, catching the photons in the SPP wave rather than allowing them to be emitted through the OLED glass substrate.

Wang’s team primarily explored another mode of loss, the coupling of dipole emission with surface plasmons at the interface between the cathode and the organic material. Surface plasmons are waves of oscillating electrons on the surface of a conductor. In OLEDs, light emitted from radiating dipoles (molecular excitons) in the emissive layer can couple to the electron oscillations in the cathode, resulting in the presence of waves called surface plasmon polaritons (SPPs). These travel along the cathode surface as they decay, carrying away the emitted photons rather than permitting them to radiate through the glass (see Figure 3).

In other words, due to the presence of the metal cathode in the close vicinity of the organic emitters, some light is absorbed by the electrons in the cathode, causing the electrons to oscillate and form SPPs. These are eventually dissipated as heat, leading to significant energy loss.

Using numerical simulation in COMSOL Multiphysics® software Wang modeled light emission from the EML and the SPPs present in the system to analyze ways to prevent light loss. One promising concept included a nanograting cathode structure

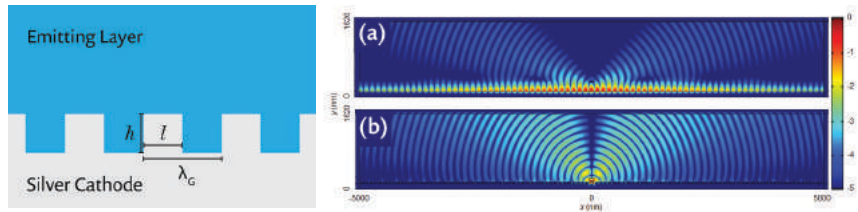

Figure 4. Left, Nanograting surface for the cathode. Wang’s simulation team tested the effects of different pitch heights and widths to determine the optimal arrangement. Right, simulated 2D field distribution of dipole emission with (a) flat and (b) nanograting cathode surfaces. For the flat surface most of the emission is coupled to the SPP wave, with only a small portion radiated as free light. The coupling is greatly suppressed by the nanograting structure in (b).

(see Figure 4, left) that disrupts the formation of the SPP mode, reducing the energy coupling between the dipole emission and the plasmons.

Wang’s simulation revealed the electromagnetic field distribution and the portion of light that escaped from the OLED for different cathode shapes (see Figure 4, right). From the results, his team was able to confirm that this phenomenon accounts for significant amounts of light lost.

COMSOL® software is an important tool at Konica Minolta Laboratory because it’s not only powerful but versatile and user-friendly. Lab personnel use the software for a variety of topics under study there. “For this OLED project we were able to do everything in COMSOL, including postprocessing the data. We also imported wavelength-dependent optical properties from our own files and incorporated them into the simulation,” Wang said.

His team modeled the OLED with flat and nanograting cathodes, changing geometric parameters to determine the optimal configuration (see Figure 5). They also performed

a simulation to study the influence of different dipole orientations, studying the effect of the dipole position and wavelength on the level of light loss due to SPPs. They used a power flow analysis to calculate the portion of light emitted from the EML that actually escaped the glass.

Through their simulations, Wang’s team determined that they could reduce the plasmon losses by 50% using the optimized nanostructure surface for the cathode.

### » VERSATILE MODELING BRINGS BRIGHTER LIGHTING

THROUGH HIS SIMULATION WORK, Wang was able to offer a promising new OLED design with significantly increased efficiency. “We were able to model the OLED system and determine the optimal configuration of the cathode nanograting structure,” he concluded. “We could understand the breakdown of loss mechanisms, easily test the influence of different design constraints, and adjust our OLEDs accordingly. COMSOL has shown us how to cut these plasmon losses in half.” ☺

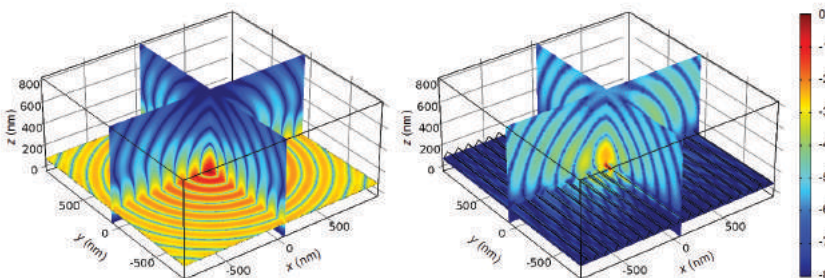
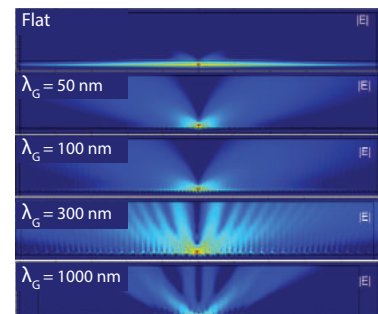

Figure 5. COMSOL® software results showing the distribution of emission when a flat structure is used (left) and a nanograting (center). The intensity is normalized and plotted on a log scale. At right are shown emission patterns for several nanograting cathode designs.



# SURFACE PLASMON POLARITONS EXPLAINED

By **ANDREW STRIKWERDA**

**SURFACE PLASMON POLARITONS**, or SPPs as they are often known, are an integral and exciting element of plasmonics and nanophotonics research. As the name suggests, SPPs are electromagnetic waves in the infrared or visible region of the spectrum propagating along surfaces, and much of the recent interest into SPPs is due to their excellent confinement of electromagnetic energy beyond the diffraction limit. As a result, they are well represented in numerous areas of near-field optics, biosensing, and metamaterials. Unfortunately, the presence of SPPs is not always desirable! In the previous article on optimization of a multilayer organic light-emitting diode (OLED), SPPs are a dominant loss factor. If the loss via SPPs can be reduced, the out-coupling efficiency of the OLED can be increased, which means better, more efficient devices for you and me. Here we will briefly discuss what an SPP is, when they may occur, and why they will automatically be accounted for in your COMSOL® software simulation.

As mentioned earlier, SPPs propagate along surfaces. But not any surface. SPPs can only propagate along an interface between two materials that have a different sign in their permittivity. Many common materials, such as air, water, plastic, and paper have a positive permittivity. Metals like gold, silver, and aluminum have a negative permittivity, and so SPPs can exist at the interface between gold and air, for example.

Just because an SPP can exist at that interface, however, does not mean that it is trivial to generate and control them. Generating an SPP with a traditional light source such as a laser is slightly more complicated, as is the inverse process – converting a SPP to visible light as in an OLED.

To couple freely propagating light and SPPs, their dispersion curves need to intersect, which is analogous to matching the energy and moment of the two. If we look at the figure shown here, the diagonal black line is the dispersion curve for light propagating freely in air, while the blue line is the dispersion curve for an SPP at an air/metal interface. The two lines approach each other asymptotically, but they do not intersect. There are several techniques to make these two curves meet, such as using a prism in either a Kretschmann or Otto configuration, but today we

will focus on the use of a grating.

A grating has a regularly repeated pattern, like a sine wave or sawtooth pattern. This periodicity has its own wavevector, which can be added (or subtracted) to the wavevector of the SPP to allow dispersion curve matching. This is represented by the red arrow in the figure.

So how do we do implement this coupling in the software? It's quite straightforward, actually. Simply create the geometry of interest, and then assign the material properties and boundary conditions as in any other high-frequency electromagnetics simulation. That's it! This is because COMSOL Multiphysics® is solving Maxwell's Equations, which means that the coupling between free space light and SPP is inherently accounted for without any additional modifications. ©

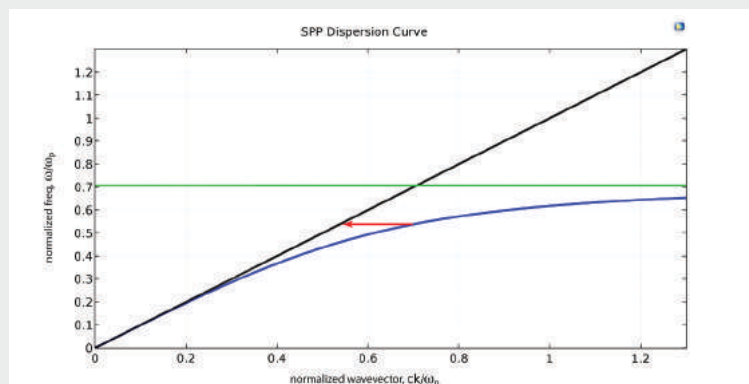

**FIGURE 1:** Plot in COMSOL® software showing the SPP dispersion curve. The black diagonal line represents the light line while the green horizontal line represents the surface plasmon frequency. The blue SPP dispersion curve approaches these asymptotically in the low- and high-frequency limit, respectively. The red arrow represents the grating wavevector that allows a surface plasmon to couple to a freely propagating light wave.

# FROM NANOANTENNAS TO DEEP SPACE SATELLITES, ELECTRON EMISSION ENABLES EFFICIENT POWER GENERATION

*Engineers at the Italian Institute of Technology (IIT) are using multiphysics analysis to illuminate ways electron emission can be used to improve power efficiency in extreme-environment technology and biomedical applications.*

By **LEXI CARVER**

**DEEP SPACE AND THE HUMAN BODY** have something in common: the challenge of designing devices that can operate in them safely, reliably, and efficiently. For equipment used in aqueous conditions, severe temperatures, high pressure levels, and other extreme environments, stable and efficient power generation can be hard to come by. The search for better power efficiency in equipment such as deep-space satellites and medical devices has recently identified electron emission as a potential method of power generation.

Electron emission occurs when a metal surface or electrode is subjected

to an electrostatic field, heat, or incoming light that causes electrons to escape the metal, often into a vacuum, so that they can be collected for usable electricity. The Italian Institute of Technology (IIT) and the European Space Agency (ESA) are collaborating to develop systems based on electron emission for solar power collection on deep-space satellites. Researchers at IIT are applying similar concepts to power nanoantennas for studying electrical signals in the brain. They use numerical analysis to study the behavior of emitted electrons and optimize their devices for best functionality and highest efficiency.

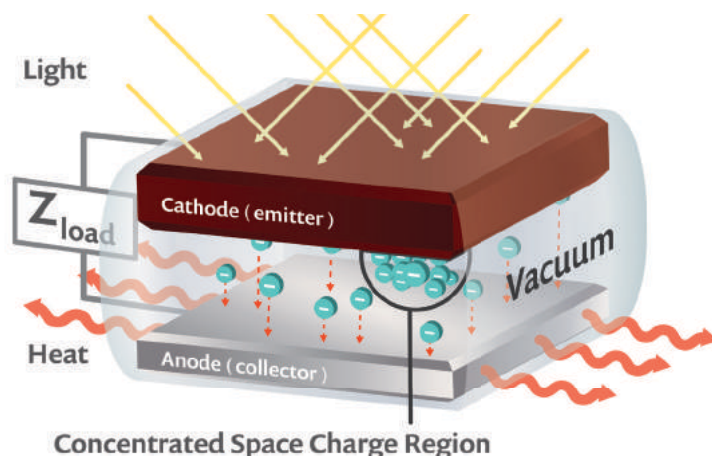

Figure 1. Schematic of a PETE. Electrons escape the cathode due to light (shone on the semiconductor) and heat (due to an electrical load). Space charge buildup occurs due to electrons getting “stuck” in the vacuum gap as they repel each other during travel to the anode.

## » BETTER SOLAR POWER IS COMING TO SATELLITES

**PHOTOVOLTAIC SYSTEMS** CONVERT sunlight into electricity and are effective for solar panels on or near Earth, but are not very efficient for near-sun missions in deep space, where high temperatures destroy the efficiency of the photovoltaic conversion. Photon-enhanced thermionic emission (PETE) solar cells, first developed in 2010 at Stanford University, offer a promising alternative by combining photovoltaics with thermionic emission — the thermally-induced flow of charge that releases electrons from a heated semiconductor — to boost power generation.

A PETE cell (see Figure 1) comprises a vacuum chamber sandwiched between an anode and a cathode made of a semiconductor such as Gallium Arsenide. Incoming photons excite electrons in the valence band of the cathode into the conduction band, causing some electrons to be released into the vacuum gap and others to shift closer to the vacuum energy level of the semiconductor, readying them for easier escape by thermionic emission. Heating the cathode then causes more electrons to “boil” away into the vacuum gap. The freed electrons travel to the anode at the other end, where they create charge buildup that can be used for electrical power.

“Photon-enhanced thermionic emission takes advantage of the semiconductor structure of the cathode and the temperature difference between cathode and anode, transforming heat into electrical power,” explained Pierfrancesco Zilio, a post-doctoral fellow at IIT. “Unlike standard photovoltaics, both the ultraviolet-visible and the infrared regions of the solar spectrum are exploited in the conversion, with the former promoting electrons to the conduction band of the semiconductor and the latter enabling their escape to the vacuum gap.”

However, the emitted electrons

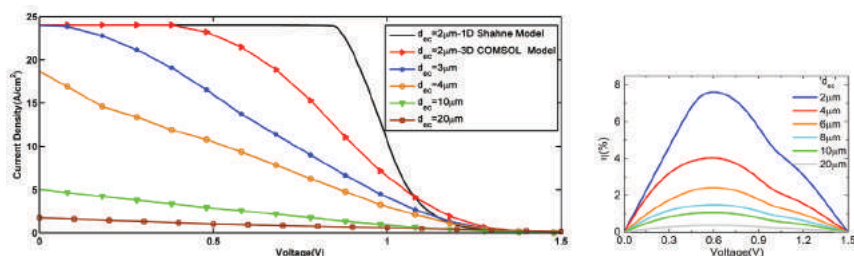

Figure 2. COMSOL® software results showing the current density at the anode (left) and power conversion efficiency (right), calculated for different distances between anode and cathode and different operating voltages.

repel each other, so some are deflected back to the cathode or get “stuck” in the middle of the vacuum gap. The latter case can create a space charge (SC) cloud that interferes with the further passage of electrons and strongly reduces the device efficiency.

### » SIMULATION LENDS A HAND

**ZILIO AND HIS COWORKERS** Waseem Raja, a PhD student, and Remo Proietti, a senior researcher, worked with the ESA to investigate different PETE systems in order to maximize charge buildup at the anode and create a design robust enough to travel aboard deep-space satellites. They used COMSOL Multiphysics® software to study the PETE cell, creating several models to analyze possible designs and determine which ones would be most practical and efficient.

His team tracked the flow of electrons between the cathode and anode and studied the formation of the space charge cloud. They began with a model that calculated the electric fields at the cathode due to the photon impact and their absorption, then analyzed the effect this had on the electrons’ ability to break free of the cathode surface.

“This allowed us to predict how the SC cloud formation would hinder electron accumulation at the anode, and therefore the final current output,” Zilio said. “We calculated the barrier the electrons had to overcome in order to reach the anode, including the energy needed to free them from the cathode and the decelerating forces

as they traveled due to the SC cloud.”

Using numerical simulation they were able to test different layouts, changing the arrangement of the two electrodes in order to see which one resulted in the highest current output and efficiency (see Figure 2). “COMSOL allowed us to couple the space charge behavior to other physical effects involved, namely light absorption and carrier transport in the cathode.”

To analyze electron emission and propagation in the vacuum chamber, they coupled a particle tracing model to the electrical and thermal model. “We determined the current density at the anode based on the electron trajectories and the electric potential,” Zilio continued. “From there we calculated the net current output and the power conversion efficiency of the PETE cell for our chosen setup.”

They also tested several strategies to minimize the space charge cloud. One concept used a cathode with a surface in the shape of a nanocone array, the rationale being that the sharp tip would result in a higher electric field and therefore more electrons emitted. Zilio modeled the electric fields and electron trajectories for a nanocone (see Figure 3), and evaluated the resulting current density at the anode.

Despite causing more electrons to be released from the cathode, the nanocone design was unable to

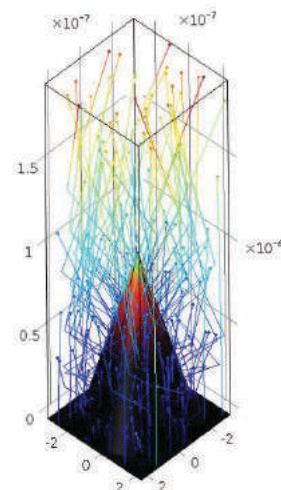

Figure 3. COMSOL results for the model of a nanocone. The plots show particle trajectories and velocity magnitude, as well as electric field norm throughout the cone surface.

overcome the SC cloud to increase the output current. So Zilio’s team turned to a new tactic. “We added a positively-charged mesh gate in the vacuum gap to attract electrons as they are released and pull them across,” he said. “This boosted electron extraction, strongly reducing the SC cloud between anode and cathode.

“Then we had to optimize the size of the holes and power used to charge the gate, so that we maintain the right compromise between efficiency, electron collection, and minimizing the number of electrons that get stuck to the gate.”

They tested different pitch sizes (the distance between centers of adjacent holes) to see which gate configuration resulted in the highest current output at the anode. They also factored in the power fed to the gate, which affects the overall conversion efficiency. Figures 4 and 5 show results for different configurations, gate voltages, and pitch sizes.

From the simulations, the team chose a gate voltage, pitch size, and

“With the range of physics we needed to simulate, such as combining particle tracing with other behavior and including strongly nonlinear phenomena, COMSOL was a huge help.”

— PIERFRANCESCO ZILIO, POST-DOCTORAL FELLOW, IIT

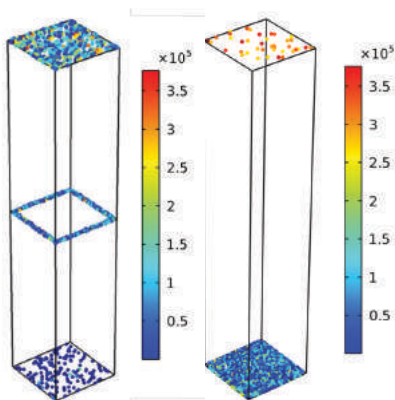

Figure 4. COMSOL results showing electron accumulation at the anode for cases with a gate (left) and without (right).

anode-cathode distance to improve the efficiency of the design. Once they'd completed studies of the PETE cell, they used similar techniques to perform plasmonic simulations of nanoantennas for biomedical and neurological equipment.

### » HOMING IN ON THE BRAIN

ZILIO ALSO USED ANALYSES IN COMSOL to investigate electron photoemission in nanoantennas, which are made of dielectric nanotubes coated with gold or silver (see Figure 6), when they are immersed in an aqueous environment representative of the human brain. These antennas will eventually be used to optically excite neurons, study electrical signals between them, and in medical treatment and diagnosis.

Submerging the antenna in a fluid environment lowers the work function, or the amount of energy required for an electron to be released from the metal. "This makes it easier for electrons to escape,

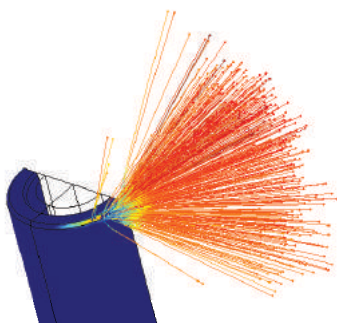

Figure 7. Particle trajectories as electrons are released from the metal.

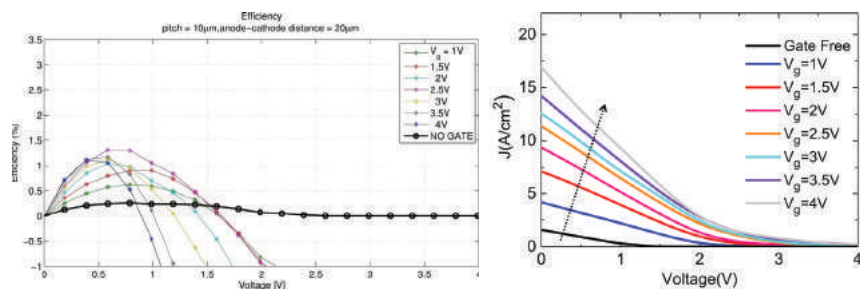

Figure 5. Simulation results show the power conversion efficiency for varying levels of voltage fed to the gate and a 20µm anode-cathode distance (left). The accumulated current density at the anode for different gate voltage levels and pitch sizes is shown at right.

but if the electron density around the antenna grows to a certain level, exponential ionization of the water molecules will occur and the antenna will no longer work," Zilio explained. Femtosecond laser pulses applied to the antenna cause plasmonic resonance that enhances the electric field at the surface of the metal, which increases the electrons' acceleration after emission.

Zilio's team coupled a simulation of the antenna's optical response to their model of electron emission and trajectories, and correlated the local field enhancement to the distribution of emitted electrons. His team then studied the "electrical hotspot," or the area with the highest electron density, and analyzed the catalytic reactions occurring based on collisions between water molecules and the emitted electrons. "The collision modeling functionality in COMSOL had everything we needed," he remarked. "I was able to simulate excitation, ionization, and elastic collisions all together."

The simulation (see Figure 7) revealed the electric field levels around the antenna and the hotspot, and predicted electron density and trajectories during release. After studying the antenna response as a function of height and laser power, the team to choose an operating range that would minimize risk of ionization and antenna failure.

### » LOOKING AHEAD TO NEW TECHNOLOGY

AS THE IIT TEAM EMBARKED on the task of optimizing the performance of deep-space satellite devices and nanoantennas, the assistance lent by multiphysics analysis proved

invaluable. "With the range of physics we needed to simulate, such as combining particle tracing with other behavior and including strongly nonlinear phenomena, COMSOL was a huge help," Zilio commented. From exploring the endless frontier of deep space to someday attempting to stimulate single neurons, engineers at IIT plan to continue using simulation to contribute to the development of technology in extreme environments. ☺

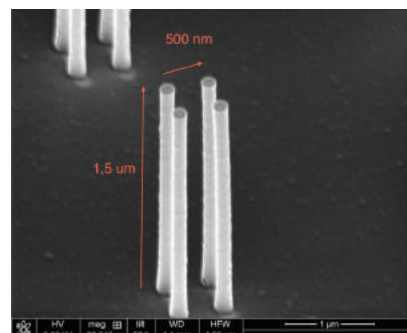
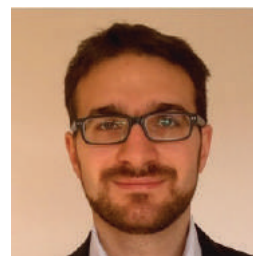

Figure 6. Close-up of gold nanotube antennas fabricated by secondary electron lithography. These antennas are able to produce strong plasmonic hotspots in the visible and near-infrared spectral ranges.



Pierfrancesco Zilio, post-doctoral fellow at IIT.

# RAY OPTICS SIMULATION LIGHTS THE WAY FORWARD

By CHRIS BOUCHER

THESE ARE EXCITING TIMES TO BE WORKING IN THE FIELD of mathematical modeling and numerical simulation of optical systems. Computational tools have become more powerful and easier to use, and can support researchers and engineers with design, optimization, and diagnostics tasks in many optical engineering applications. Simulation specialists are focused on reproducing the behavior of real-world systems as accurately as possible, reducing the dependence on prototyping and experimentation. Here we will discuss how the tools available in COMSOL Multiphysics® software allow for the needed accuracy, specifically in high-frequency optics.

## » INTEGRATED SOFTWARE STREAMLINES THE DESIGN PROCESS

THE COMSOL MULTIPHYSICS SOFTWARE SUITE has traditionally been a fully integrated, multidisciplinary modeling and simulation tool. Among the software's greatest strengths is its ability to incorporate every step of the simulation process, including geometry setup, physics, meshing, solving, and results evaluation, into a single streamlined user interface (Figure 1).

During the development of the Ray Optics Module, an add-on product of the COMSOL® software, it was obvious that this self-contained workflow had to be a strength of the ray tracing tools as well. Many users had expressed a similar frustration while working in optical simulation: the need to exchange data between several different, more specialized software packages in order to accurately depict real-world systems. Thus, the Ray Optics Module was designed to

be a comprehensive and self-contained solution for every step of the modeling process.

## » THE MULTIPHYSICS APPROACH EXTENDS OPTICAL SIMULATION CAPABILITIES

WHEN EXTREMELY HIGH accuracy is required, an optical model becomes very complex, or when devices are exposed to extreme environments, often it is not sufficient to consider electromagnetic wave phenomena alone. In COMSOL, the output of electromagnetic wave simulations can seamlessly be combined with governing equations for other physical phenomena to capture effects such as Joule heating, microwave heating, laser heating, the piezoelectric effect, magnetostriction, and even semiconductor

optoelectronics.

Because multiphysics simulation has long been a central tenet of COMSOL's philosophy, it quickly became obvious that the same principle had to apply to ray optics modeling in the software. The ray optics tool had to be implemented in a versatile enough manner that it could easily be combined with the rest of the modules in the product suite, which support electrical, fluid, mechanical, thermal, and chemical analysis.

## » UNIDIRECTIONAL AND BIDIRECTIONAL THERMAL COUPLINGS

AMONG THE MOST HIGH-END features of the Ray Optics Module is its capability for unidirectional or bidirectional coupling to other physics, most notably heat transfer and structural mechanics. Unidirectional, or one-way, coupling is observed when rays simply heat an absorbing material or a surface, or when the ray directions are perturbed by structural deformations.

Unidirectional couplings are observed, for example, in solar thermal energy (STE) applications (Figure 2). High temperature collectors usually involve a reflective parabolic trough or dish, or an array of such reflectors, which focus solar energy to a small target, or receiver. Both the magnitude and distribution of the incident heat flux at the receiver have large effects on the efficiency of the conversion of solar energy to electricity.

A bidirectional, or two-way, coupling occurs when a high-powered beam induces structural and thermal changes in the simulation domain, which in turn perturb the ray trajectories (Figure

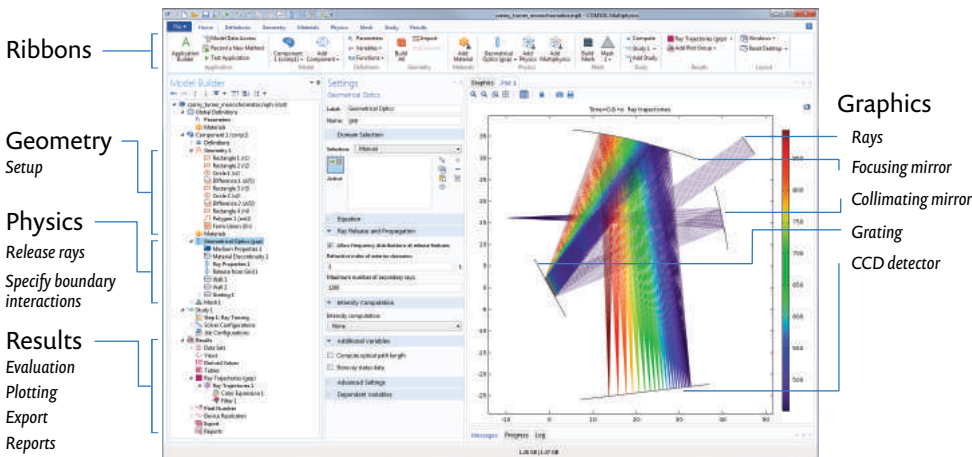

Figure 1. The software user interface provides access to every step of the model setup.

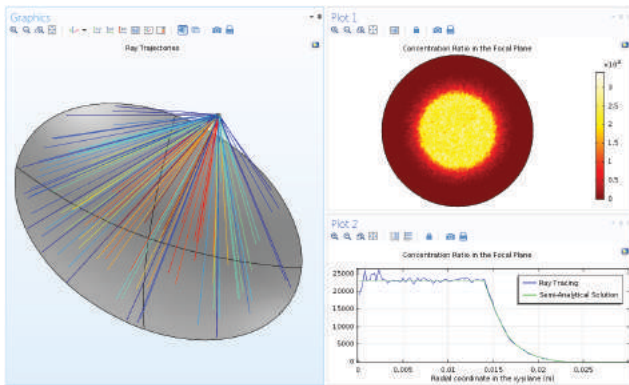

Figure 2. Solar rays are reflected by a parabolic dish and focused toward a small receiver (left). The ratio of incident heat flux to ambient solar flux, or concentration ratio, is plotted in the focal plane of the dish (upper right). In this benchmark model, the concentration ratio as a function of radial position compares well to a known solution (lower right).

3). A temperature shift can affect the ray paths through a lens system by several mechanisms, including temperature- and strain-dependence of the refractive index and thermal expansion.

The bidirectional coupling between ray propagation and the structural and thermal effects can be seen in phenomena such as thermal lensing, in which a high-powered beam propagating through a slab of an absorbing material will be focused somewhat (Figure 4). It is also possible to observe and quantify thermally induced focal shift, the change in the focal position in a lens system due to thermal expansion and changes in the refractive index.

### » USER-DRIVEN FEATURES GUIDE PROGRESS IN RAY OPTICS SIMULATION

AS A SPECIALIZED PART of a general-purpose modeling and simulation software package, the Ray Optics Module has built upon many of the convenient features that are found throughout the entire product suite. As feedback

from users continues to pour in, however, the need for application-specific functionality in key areas has been recognized, such as dedicated solver sequences and postprocessing features. For example, specialized plots for visualizing monochromatic aberrations such as coma, defocus, astigmatism, and spherical aberration are now available (Figure 5).

The ability to quantify and visualize optical aberrations in COMSOL Multiphysics® software is a powerful complement to the multiphysics capability of the Ray Optics Module. It is now easier than ever to observe how factors such as temperature changes and stresses can distort an image.

### » LOOKING FORWARD

AS IN MOST SUBJECT AREAS, the increasing prevalence of computational models in optical systems has illustrated the need for an integrated modeling and simulation environment. The introduction of specialized plot tools for aberrations is yet another step toward supporting

specialists who work in the area of optics with a general-purpose high-frequency optical simulation tool that can be used for almost any application. The underlying physics and mathematics of geometrical optics are readily extensible to a tremendous variety of industries, including ophthalmology, solar energy harvesting, and design of cameras, telescopes, monochromators, and spectrometers.

Furthermore, the capability to incorporate thermal and structural phenomena into ray tracing simulations allows for accurate, high-end multiphysics models of complex devices and systems, even when operating under extreme conditions. The multiphysics approach enables simulation specialists, engineers, and designers to lead innovation in the high-tech, fast-paced optics industry and beyond. ©

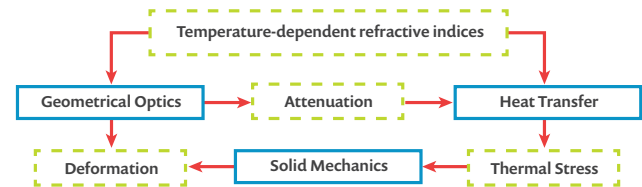

Figure 3. Typical workflow for a bidirectionally coupled simulation with optical, thermal, and structural effects.

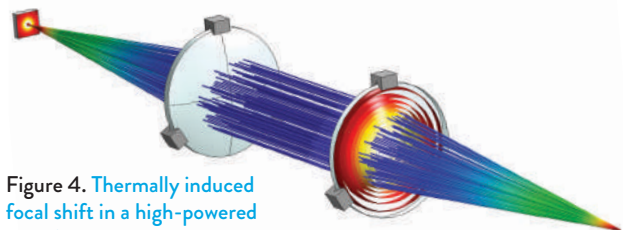

Figure 4. Thermally induced focal shift in a high-powered laser focusing system.

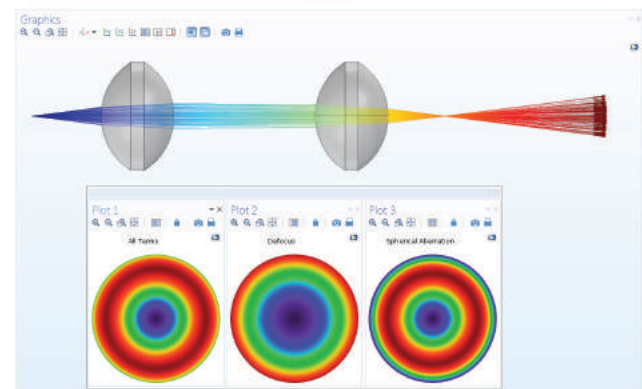

Figure 5. Ray trajectories in a system of two convex lenses. The monochromatic aberrations are plotted as a superposition of the Zernike polynomials, from which individual terms can be selected.

# COMPUTATIONAL NANOPHOTONICS: FROM OPTICAL BLACK HOLES TO PLASMON TWEEZERS

By ALEXANDER V. KILDISHEV

COMPUTATIONAL NANOPHOTONICS, or CNP, has a broad range of applications in physics, photochemistry, and engineering. Nanoscale nonlinear optics, enhanced light harvesting, dielectric metasurfaces, plasmonic nanolasers, spasers, and graphene nanophotonics are just a few examples.

The choice of computational tools for the numerical simulation of nanophotonic applications depends on capabilities for modeling the complex interplay between nanoscale-confined light and nanoscale-confined matter phenomena. In most cases the near-field interaction is also translated into the far-field radiation, which results in a huge geometrical scale mismatch where an accurate mathematical representation is of the essence.

Choosing the right tool is challenging — yet COMSOL Multiphysics® software fits these tough requirements for many practical applications. My collaborators and I have used it with success in the multidisciplinary field of mathematical modeling for nanophotonics. My current research focuses on developing methods for CNP to design 3D optical metamaterials and low-dimensional metamaterial structures, or metasurfaces, capable of guiding and manipulating light in unusual, extraordinary ways. I also work with the development of gain-assisted plasmonic nanostructures.

The initial effort in this direction and more recent research have already brought us closer to designing a new enabling machinery for active nanophotonics. These studies are performed in close collaboration with Prof. Shalaev (Purdue) and

Prof. Klar (Johannes Kepler University, Austria). Working with Prof. Narimanov (Purdue) and Dr. Prokopeva (Novosibirsk State University, Russia) has resulted in exact full-wave and approximate transformation optics methods for optimizing omnidirectional light absorbers, or optical black holes, which we most recently tested using the Wave Optics and Ray Optics Modules available with COMSOL® software (J. Opt. vol. 18, p. 044014, 2016).

Our graduate student Justus Ndukaife introduced an original design for plasmon-assisted optical trapping (see figure). Plasmon nano-optical tweezers are being actively investigated as an elegant approach to stably trap submicron and nanoscale objects. At Purdue, Justus fabricated a prototype in Prof. Boltasseva's lab and successfully compared numerical results with the experimental data obtained from a setup designed by Prof. Wereley (see Nat. Nanotechnol., vol. 11, pp. 53-59, 2016). There are complex multiphysics phenomena present in such devices, which are described by tightly coupled systems of PDEs. Nanotweezers can be used in applications such as the manipulation and analysis of micro- and nano-objects in biosensing,

programmable nanoassembly, ultra-resolved optofluidic screens, and plasmonic circuitry for integrated quantum logic units.

CNP is a growing field that is, and will continue to have, an important impact on everyday life. With the right computational tools, we are able to validate our theoretical assumptions and designs, and analyze nanophotonics problems in their entirety. ©

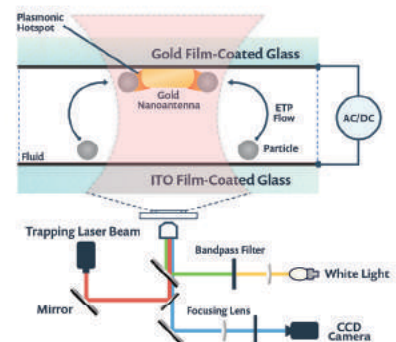

**Design of a nanotweezer.** The illuminated plasmonic nanoantenna heats the fluid and induces local gradients in its electrical permittivity and conductivity. An applied AC field induces electrothermoplasmonic (ETP) flow, enabling delivery of particles to plasmonic hotspots. Switching the AC field to DC immobilizes the particles held in the plasmonic hotspots.

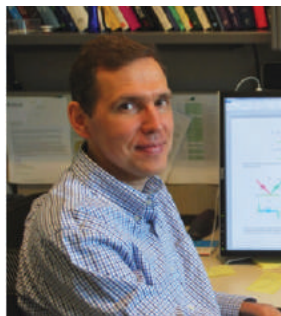

**ALEXANDER V. KILDISHEV** is an Associate Professor with the School of Electrical and Computer Engineering and the Birck Nanotechnology Center, Purdue University, USA. Prof. Kildishev belongs to a handful of world-leading experts in the field of numerical modeling of nanophotonic structures and devices in real-life environments. His results include a number of breakthroughs in negative refractive index metamaterials, optical artificial magnetic structures, loss compensation in metamaterials, plasmonic nanolasers, and optical metasurfaces, as well as the theory and numerical models of optical cloaks and hyperlenses.